

## Voltage transducer

$V_{PN} = 2800\text{ V}$

### Ref: DV 2800/SP4

For the electronic measurement of voltage: DC, AC, pulsed..., with galvanic isolation between the primary and the secondary circuit.

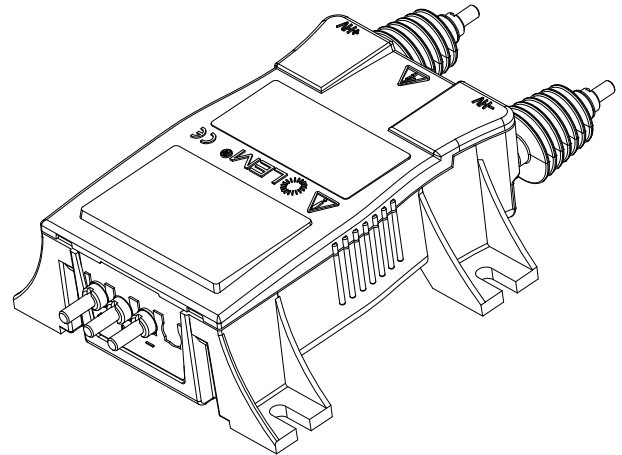

#### Features

- Bipolar and isolated voltage measurement up to 4.2 kV
- Current output
- Input and output connections by M5 studs
- Footprint compatible with OV, CV4 series and LV 200-AW/2 families.

#### Advantages

- Low consumption and losses
- Compact design
- Good behaviour under common mode variations
- Excellent accuracy (offset, sensitivity, linearity)
- Response time 60  $\mu\text{s}$
- Low temperature drift
- High immunity to external interferences.

#### Applications

- Single or three phase inverter
- Propulsion and braking chopper
- Propulsion converter
- Auxiliary converter
- High power drives
- Substations
- On-board energy meters.

#### Standards

- EN 50155
- EN 50121-3-2
- EN 50124-1
- Isolated plastic case material recognized according to UL 94-VO.

#### Application Domain

- Traction (fix and onboard).

### Absolute maximum ratings

Parameter	Symbol	Value
Maximum supply voltage ( $V_p = 0, 0.1 \text{ s}$ )		$\pm 34 \text{ V}$
Maximum supply voltage (working) (-40 .. 85 °C)	$\pm V_C$	$\pm 26.4 \text{ V}$
Maximum input voltage (-40 .. 85 °C)		4.2 kV
Maximum steady state input voltage (-40 .. 85 °C)	$V_{PN}$	2800 V see derating on figure 2

Absolute maximum ratings apply at 25°C unless otherwise noted.

Stresses above these ratings may cause permanent damage. Exposure to absolute maximum ratings for extended periods may degrade reliability.

### Isolation characteristics

Parameter	Symbol	Unit	Min	Comment
RMS voltage for AC isolation test 50/60Hz/1 min	$V_d$	kV	18.5	100 % tested in production
Maximum impulse test voltage (1.2/50 $\mu\text{s}$ exponential shape)		kV	30	
Isolation resistance	$R_{IS}$	M $\Omega$	200	measured at 500 V DC
Partial discharge extinction voltage rms @ 10 pC	$V_e$	V	5000	
Comparative tracking index	<b>CTI</b>	V	600	
Clearance and creepage	See dimensions drawing on page 8			

### Environmental and mechanical characteristics

Parameter	Symbol	Unit	Min	Typ	Max
Ambient operating temperature	$T_A$	°C	-40		85
Ambient storage temperature	$T_S$	°C	-50		90
Mass	$m$	g		620	
Standards	EN 50155: 2007 EN 50121-3-2: 2006 EN 50124-1: 2001				

**Electrical data DV 2800/SP4**

At  $T_A = 25^\circ\text{C}$ ,  $\pm V_C = \pm 24\text{ V}$ ,  $R_M = 100\ \Omega$ , unless otherwise noted.

Lines with a \* in the conditions column apply over the  $-40 \dots 85^\circ\text{C}$  ambient temperature range.

Parameter	Symbol	Unit	Min	Typ	Max	Conditions
Primary nominal voltage, rms	$V_{PN}$	V			2800	*
Primary voltage, measuring range	$V_{PM}$	V	-4200		4200	*
Measuring resistance	$R_M$	$\Omega$	0		133.3	* See derating on figure 2. For $ V_{PM}  < 4200\text{ V}$ , max value of $R_M$ is given in figure 1
Secondary nominal current, rms	$I_{SN}$	mA			50	*
Output range	$I_S$	mA	-75		75	*
Supply voltage	$\pm V_C$	V	$\pm 13.5$	$\pm 24$	$\pm 26.4$	*
Supply rise time (10-90%)		ms			100	
Current consumption @ $V_C = \pm 24\text{ V}$	$I_C$	mA		$20 + I_S$	$25 + I_S$	
Offset current	$I_O$	$\mu\text{A}$	-50	0	50	100% tested in production
Offset drift	$I_{OT}$	$\mu\text{A}$	-120 -120 -150		120 120 150	* -25 .. 70 °C -25 .. 85 °C -40 .. 85 °C, 100% tested in production
Sensitivity	<b>G</b>	$\mu\text{A/V}$		17.8571		50 mA for 2800 V
Sensitivity error	$\varepsilon_G$	%	-0.2	0	0.2	
Thermal drift of sensitivity	$\varepsilon_{GT}$	%	-0.5 -0.8 -0.8		0.5 0.8 0.8	* -25 .. 70 °C -25 .. 85 °C -40 .. 85 °C
Linearity error	$\varepsilon_L$	%	-0.1		0.1	* $\pm 4200\text{ V}$ range
Overall accuracy	$X_G$	% of $V_{PN}$	-0.3 -0.7 -1.0 -1.0		0.3 0.7 1.0 1.0	* 25°C; 100% tested in production -25 .. 70 °C -25 .. 85 °C, -40 .. 85 °C
Output current noise, rms	$i_{no}$	$\mu\text{A}_{\text{rms}}$		10		1 Hz to 100 kHz
Reaction time @ 10 % of $V_{PN}$	$t_{ra}$	$\mu\text{s}$		21		
Response time @ 90 % of $V_{PN}$	$t_r$	$\mu\text{s}$		48	60	0 to 2800 V step, 6 kV/ $\mu\text{s}$
Frequency bandwidth	<b>BW</b>	kHz		12 6.5 1.6		3 dB 1 dB 0.1 dB
Start-up time		ms		190	250	*
Primary resistance	$R_1$	M $\Omega$		23		*
Total primary power loss @ $V_{PN}$	<b>P</b>	W		0.34		*

Typical performance characteristics

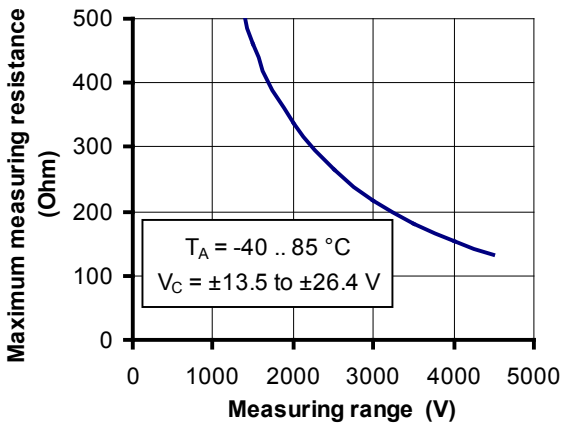

Figure 1: Maximum measuring resistance

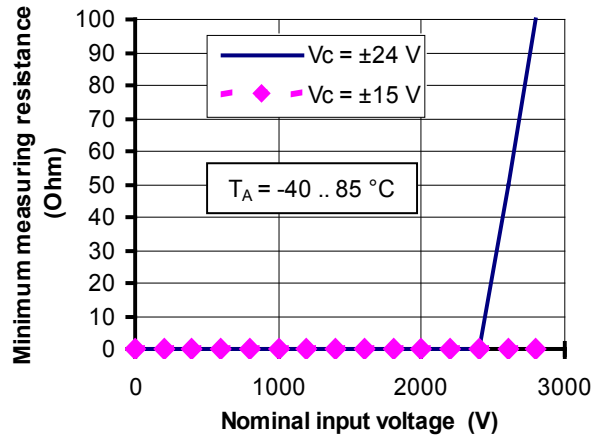

Figure 2: Minimum measuring resistance; For  $T_A$  under  $80^{\circ}\text{C}$ , the minimum measuring resistance is  $0\ \Omega$  whatever  $V_C$

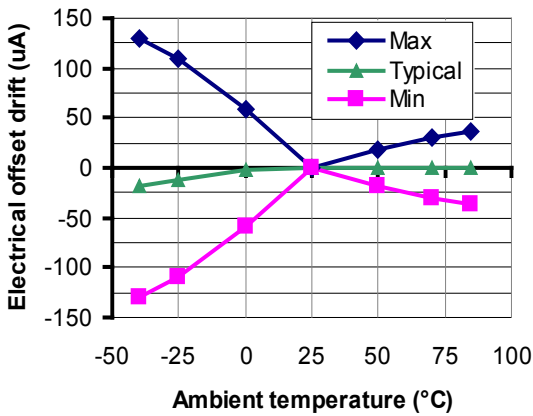

Figure 3: Electrical offset thermal drift

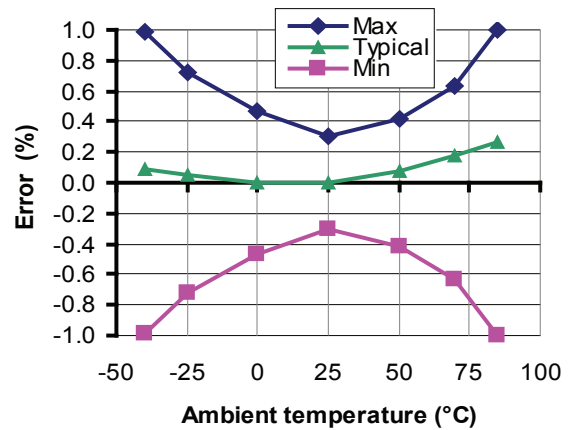

Figure 4: Overall accuracy in temperature

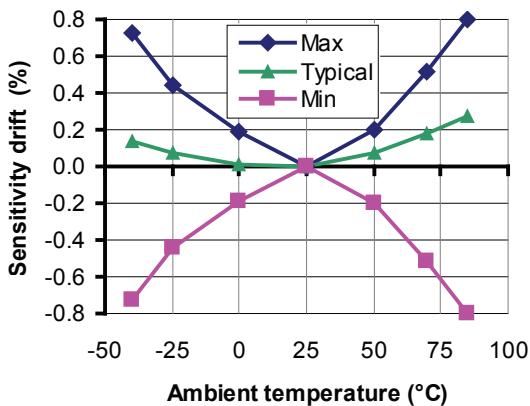

Figure 5: Sensitivity thermal drift

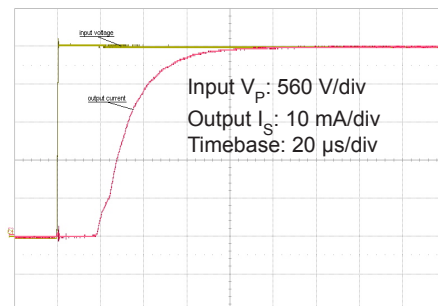

Figure 6: Typical step response (0 to 2800 V)

Typical performance characteristics (continued)

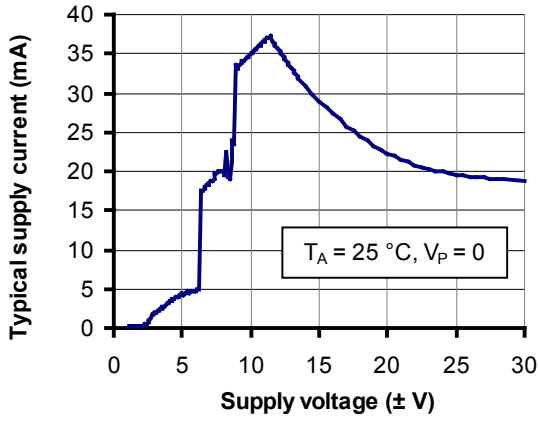

Figure 7: Supply current function of supply voltage

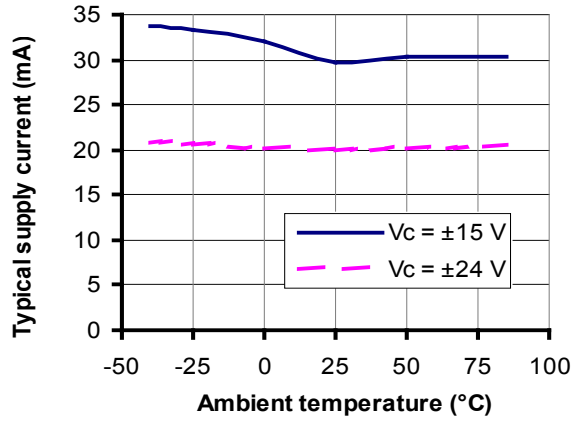

Figure 8: Supply current function of temperature

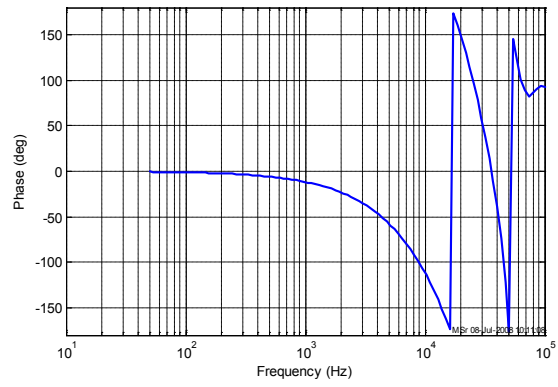
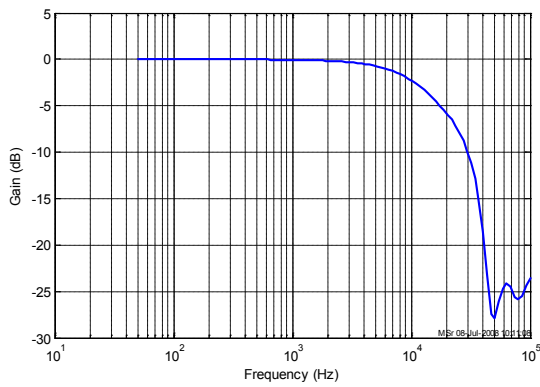

Figure 9: Typical frequency response

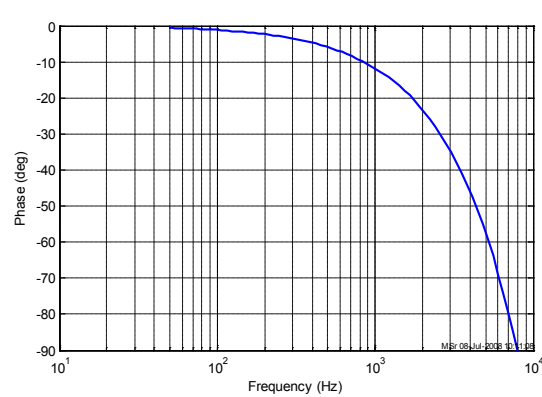
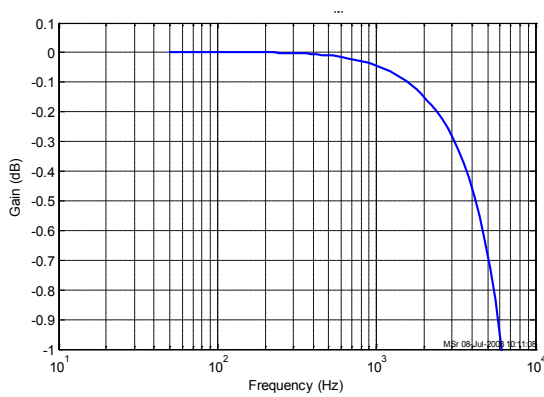

Figure 10: Typical frequency response (detail)

Typical performance characteristics (continued)

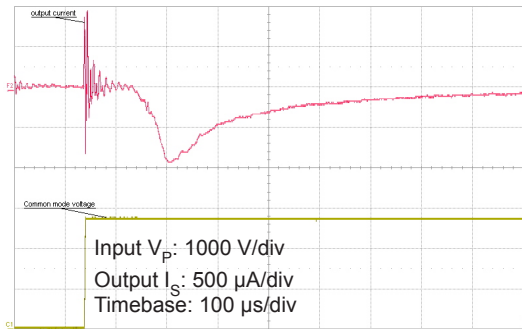

Figure 11: Typical common mode perturbation (2800 V step with 6 kV/µs  $R_M = 100 \Omega$ )

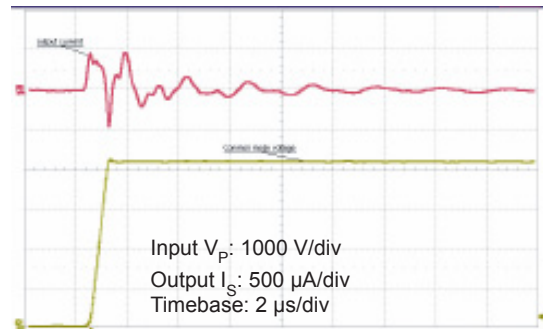

Figure 12: Detail of typical common mode perturbation (2800 V step with 6 kV/µs,  $R_M = 100 \Omega$ )

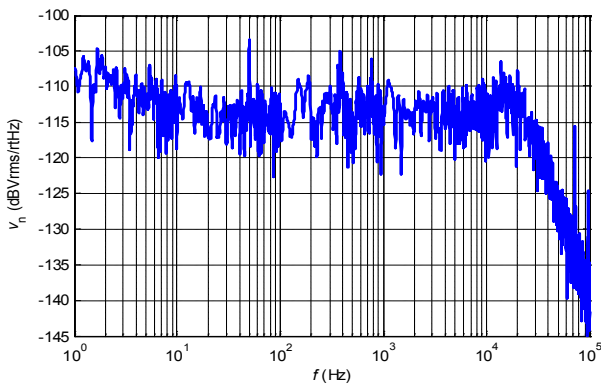

Figure 13: Typical noise power density of V ( $R_M$ ) with  $R_M = 50 \Omega$

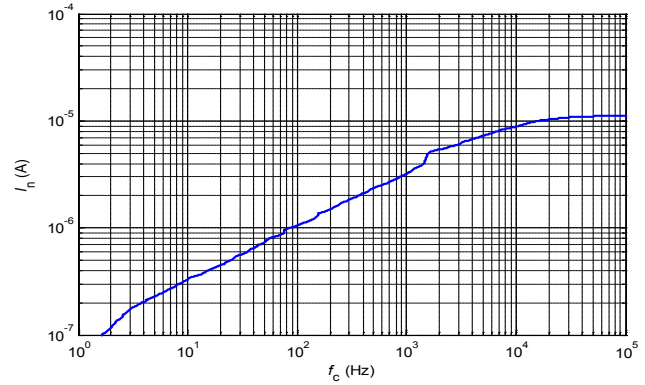

Figure 14: Typical total output current noise (rms) with  $R_M = 50 \Omega$  ( $f_c$  is upper cut off frequency of bandpass, low cut off frequency is 1 Hz)

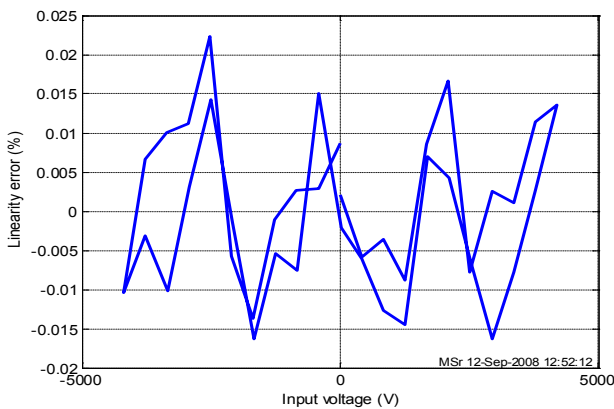

Figure 15: Typical linearity error

Figure 13 (noise power density) shows that there are no significant discrete frequencies in the output. Figure 14 confirms that because there are no steps in the total output current noise that would indicate discrete frequencies (there is only a small step around 1.5 kHz).

To calculate the noise in a frequency band  $f1$  to  $f2$ , the formula is

$$In(f1 \text{ to } f2) = \sqrt{In(f2)^2 - In(f1)^2}$$

with  $In(f)$  read from figure 14 (typical, rms value).

Example:

What is the noise from 10 to 100 Hz?

Figure 14 gives  $In(10 \text{ Hz}) = 0.32 \mu\text{A}$  and  $In(100 \text{ Hz}) = 1 \mu\text{A}$ .

The output current noise (rms) is therefore

$$\sqrt{(1 \cdot 10^{-6})^2 - (0.32 \cdot 10^{-6})^2} = 0.95 \mu\text{A}$$

## Performance parameters definition

The schematic used to measure all electrical parameters are:

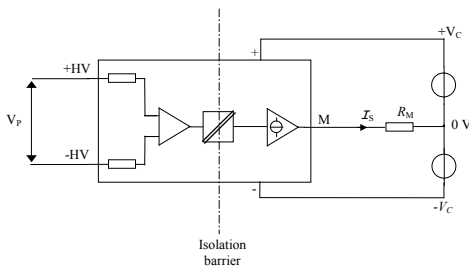

Figure 16: standard characterization schematics for current output transducers ( $R_M = 50 \Omega$  unless otherwise noted)

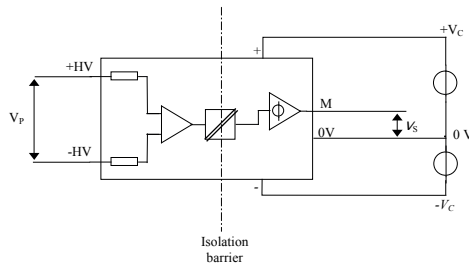

Figure 17: standard characterization schematics for voltage output transducers ( $R_M = 100 \text{ k}\Omega$  unless otherwise noted)

For all the following explanations, the output currents  $I_S$ ,  $I_O$ ,  $I_{OT}$ , etc. should be replaced by voltages for transducers with voltage output:  $V_S$ ,  $V_O$ ,  $V_{OT}$  etc.

### Transducer simplified model

The static model of the transducer at temperature  $T_A$  is:

$$I_S = G V_P + \text{error}$$

In which

$$\text{error} = I_{OE} + I_{OT}(T_A) + \varepsilon_G G V_P + \varepsilon_{GT}(T_A) G V_P + \varepsilon_L G V_{PM}$$

- $I_S$  : the secondary current (A)
- $G$  : the sensitivity of the transducer (A/V)
- $V_P$  : the voltage to measure (V)
- $V_{PM}$  : the measuring range (V)
- $T_A$  : the ambient temperature ( $^{\circ}\text{C}$ )
- $I_{OE}$  : the electrical offset current (A)
- $I_{OT}(T_A)$  : the temperature variation of  $I_O$  at temperature  $T_A$  (A)
- $\varepsilon_G$  : the sensitivity error at  $25^{\circ}\text{C}$  at temperature  $T_A$
- $\varepsilon_{GT}(T_A)$  : the thermal drift of sensitivity at temperature  $T_A$
- $\varepsilon_L$  : the linearity error

This is the absolute maximum error. As all errors are independent, a more realistic way to calculate the error would be to use the following formula:

$$\text{error} = \sqrt{\sum (\text{error\_component})^2}$$

### Sensitivity and linearity

To measure sensitivity and linearity, the primary voltage (DC) is cycled from  $V_{PM}$ , then to  $-V_{PM}$  and back to 0 (equally spaced  $V_{PM}/10$  steps).

The sensitivity  $G$  is defined as the slope of the linear regression line for a cycle between  $\pm V_{PM}$ .

The linearity error  $\varepsilon_L$  is the maximum positive or negative difference between the measured points and the linear regression line, expressed in % of the maximum measured value.

### Magnetic offset

Due to its working principle, this type of transducer has no magnetic offset current  $I_{OM}$ .

### Electrical offset

The electrical offset current  $I_{OE}$  is the residual output current when the input voltage is zero.

The temperature variation  $I_{OT}$  of the electrical offset current  $I_{OE}$  is the variation of the electrical offset from  $25^{\circ}\text{C}$  to the considered temperature.

### Overall accuracy

The overall accuracy  $X_G$  is the error at  $\pm V_{PN}$ , relative to the rated value  $V_{PN}$ .

It includes all errors mentioned above.

### Response and reaction times

The response time  $t_r$  and the reaction time  $t_{ra}$  are shown in the next figure.

Both slightly depend on the primary voltage  $dV/dt$ . They are measured at nominal voltage.

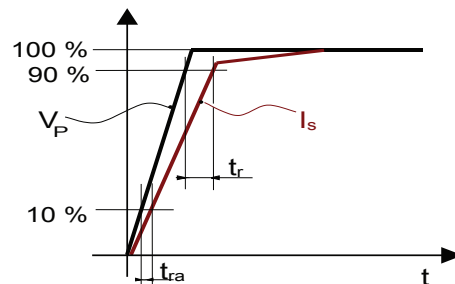
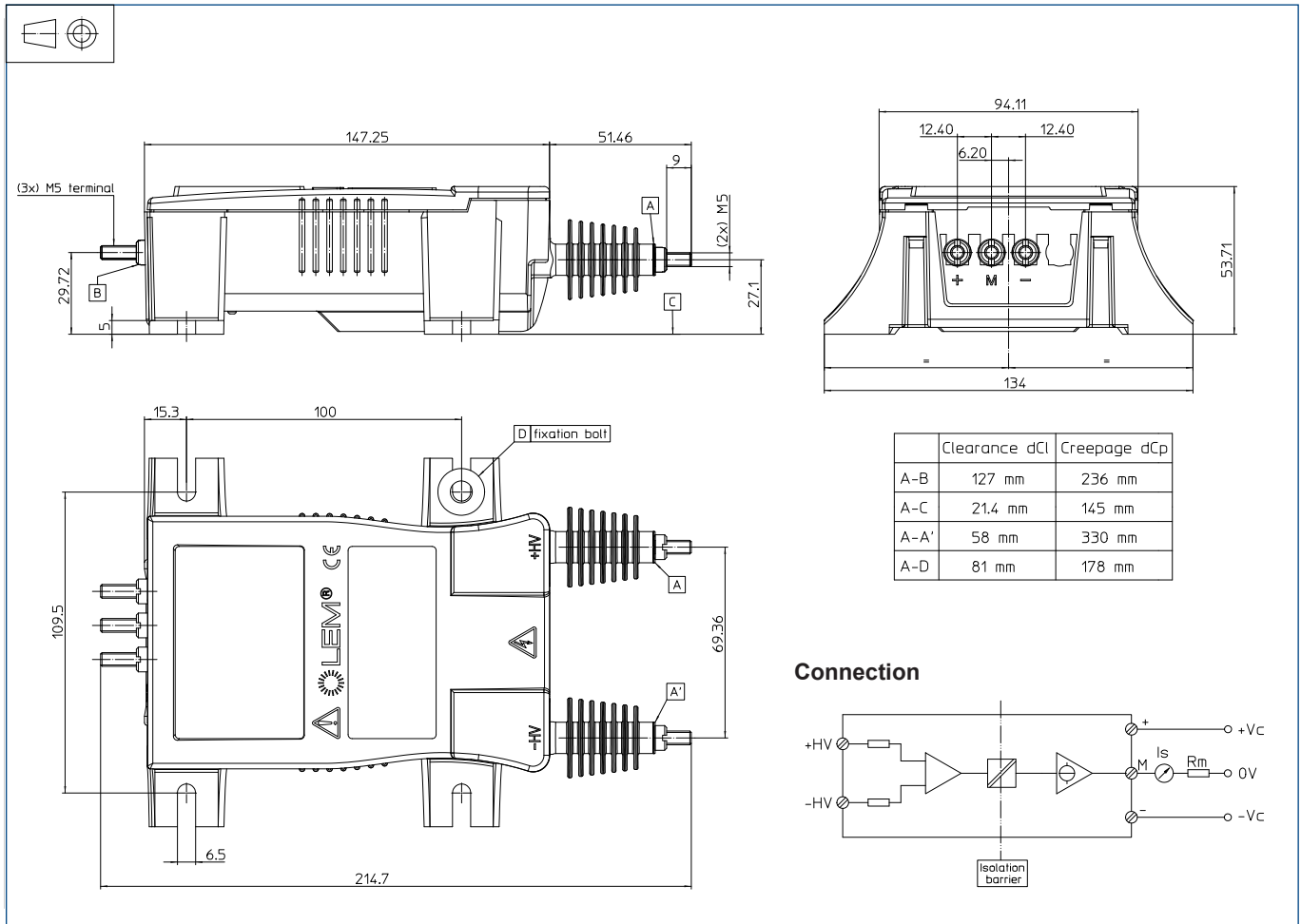

Figure 18: response time  $t_r$  and reaction time  $t_{ra}$

**Dimensions DV 2800/SP4 (in mm)**

**Mechanical characteristics**

- General tolerance  $\pm 1$  mm
- Transducer fastening
  - 4 M6 steel screws
  - 4 washers of ext.  $\varnothing 18$  mm
- Recommended fastening torque 5 Nm
- Connection of primary
  - M5 threaded studs
  - Recommended fastening torque 2.2 Nm
- Connection of secondary
  - M5 threaded studs
  - Recommended fastening torque 2.2 Nm

**Remarks**

- $I_s$  is positive when a positive voltage is applied on +HV.
- The transducer is directly connected to the primary voltage.
- The primary cables have to be routed together all the way.
- The secondary cables also have to be routed together all the way.
- Installation of the transducer is to be done without primary or secondary voltage present.

**Safety**

This transducer must be used in electric/electronic equipment with respect to applicable standards and safety requirements in accordance with the manufacturer's operating instructions.



Caution, risk of electrical shock

When operating the transducer, certain parts of the module can carry hazardous voltage (eg. primary busbar, power supply). Ignoring this warning can lead to injury and/or cause serious damage. This transducer is a build-in device, whose conducting parts must be inaccessible after installation. A protective housing or additional shield could be used. Main supply must be able to be disconnected.