

AUTOMOTIVE CURRENT TRANSDUCER FLUXGATE TECHNOLOGY

CAB 500-C/SP1, CAB 500-C/SP2, CAB 500-C/SP5, CAB 500-C/SP5-001, CAB 500-C/SP5-002,

CAB 500-C/SP5-012, CAB 500-C/SP7, CAB 500-C/SP10, CAB 500-C/SP77



Introduction

The CAB family is for battery monitoring applications where high accuracy and very low offset are required. It offers galvanic separation between primary circuit (high voltage) and the secondary circuit (12 V system).

Features

- Transducer using Fluxgate technology
- Overcurrent detection mechanism
- Panel mounting
- Unipolar +12 V battery power supply
- Output signal: High speed CAN (up to 500 kbps)
- Configurable internal digital low-pass frequency filter
- Connector type: Tyco AMP 1473672-1
- Configurable CAN speed/CAN ID
- UL508 compliant
- Ingress Protection - IP42 level.

Advantages

- Offset below 10 mA
- Total error 0.3 % at 25 °C
- Total error 0.5 % at -40 °C to 85 °C
- Full galvanic separation.

Automotive applications

- Hybrid and electric vehicle battery pack
- Conventional lead-acid batteries
- Accurate current measurement for battery management applications (SOC, SOH, SOF, etc...).

Principle of Fluxgate Transducers

A low-frequency fluxgate transducer is made of a wound core which saturates under low induction. A current chopper switches the winding's current to saturate the magnetic core alternatively at $\pm B$ max with a fixed frequency. Fluxgate transducers use the change of the saturation's point symmetry to measure the primary current. Due to the principle of switching the current, all offsets (electric and magnetic) are cancelled.

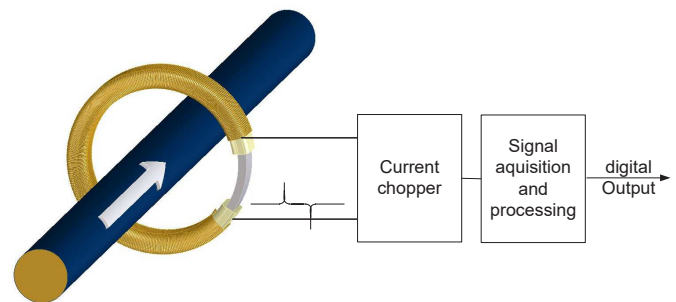

Safety



Caution

If the device is used in a way that is not specified by the manufacturer, the protection provided by the device may be compromised. Always inspect the electronics unit and connecting cable before using this product and do not use it if damaged. Mounting assembly shall guarantee the maximum primary conductor temperature, fulfill clearance and creepage distance, minimize electric and magnetic coupling, and unless otherwise specified can be mounted in any orientation.



Caution, risk of electrical shock

This transducer must be used in limited-energy secondary circuits SELV according to IEC 61010-1, in electric/electronic equipment with respect to applicable standards and safety requirements in accordance with the manufacturer's operating specifications.

Use caution during installation and use of this product; certain parts of the module can carry hazardous voltages and high currents (e.g. power supply, primary conductor). Ignoring this warning can lead to injury and or/cause serious damage.

This transducer is a build-in device, whose hazardous live parts must be inaccessible after installation.

This transducer must be mounted in a suitable end-enclosure.

Besides make sure to have a distance of minimum 30 mm between the primary terminals of the transducer and other neighboring components.

This transducer is a built-in device, not intended to be cleaned with any product. Nevertheless if the user must implement cleaning or washing process, validation of the cleaning program has to be done by himself.



ESD susceptibility

The product is susceptible to be damaged from an ESD event and the personnel should be grounded when handling it.

Do not dispose of this product as unsorted municipal waste. Contact a qualified recycler for disposal.

Although LEM applies utmost care to facilitate compliance of end products with applicable regulations during LEM product design, use of this part may need additional measures on the application side for compliance with regulations regarding EMC and protection against electric shock. Therefore LEM cannot be held liable for any potential hazards, damages, injuries or loss of life resulting from the use of this product.



Underwriters Laboratory Inc. recognized component

UL 508: Ratings and assumptions of certification

File # E189713 Volume: 2 Section: 12

Standards

 CSA C22.2 NO. 14-10 INDUSTRIAL CONTROL EQUIPMENT - Edition 13
 UL 508 STANDARD FOR INDUSTRIAL CONTROL EQUIPMENT - Edition 18

Ratings

Parameter	Symbol	Unit	Value
Primary involved potential		V AC/DC	600
Max surrounding air temperature	T_A	°C	85
Primary current	I_P	A	500
Secondary supply voltage	U_C	V DC	18
Output voltage	U_{out}	V	0 to 5

Conditions of acceptability

When installed in the end-use equipment, consideration shall be given to the following:

- 1 - *These products must be mounted in a suitable end-use enclosure.*
- 2 - *The secondary circuit pin terminals have not been evaluated for field wiring.*
- 3 - *Low voltage control circuit shall be supplied by an isolated source of supply.*
- 4 - *These products shall be used in a pollution degree 2 environments or better.*
- 5 - *Primary feeder of the devices shall be connected after an overvoltage device or system which has been evaluated by the Standard for Transient Voltage Surge Suppressors, UL 1449 with a maximum clamping voltage of 6 kV.*

Marking

Only those products bearing the UR Mark should be considered to be Listed or Recognized and covered under UL's Follow-Up Service. Always look for the Mark on the product.

CAB 500-C Series Hardware summary

CAB 500-C series	Plastic	Mass	Hardware feature	Mounting recommendation		
				Metal insert mounting ears	Screw recommendation	Torque recommendation
CAB 500-C/SP1 CAB 500-C/SP10	PBT-GF30	68 g	-	Yes	M6	8 Nm ± 20 %
CAB 500-C/SP2		67 g	Choke coil on CAN interface	-	Plastic-rivet	Max load 70 N
CAB 500-C/SP5 CAB 500-C/SP5-001 CAB 500-C/SP5-002		67 g	-	-	Plastic-rivet	Max load 70 N
CAB 500-C/SP5-012		67 g	Integrated 120 ohm termination resistor	-	Plastic-rivet	Max load 70 N
CAB 500-C/SP7 CAB 500-C/SP77		70 g	-	Yes	M4	2 Nm ± 5 %

Laser Marking

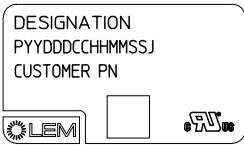
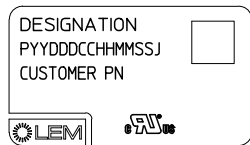
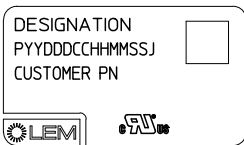
Designation	Datecode	2D matrix	2D matrix content	Text marking area
CAB 500-C/SP1	P = Production center ID YY = Last two digit of the year DDD = Day number of the year CC = Machine ID HH = Hour MM = Minute SS = Second J = Machine jig ID	YES	294C12911RTPYYDDDC HHMMSSJ	
CAB 500-C/SP2		NO	-	
CAB 500-C/SP5		YES	90.H5.50.005.0PYYDDDC HHMMSSJ	
CAB 500-C/SP5-001		YES	90.H5.50.015.0PYYDDDC HHMMSSJ	
CAB 500-C/SP5-002		YES	90.H5.50.025.0PYYDDDC HHMMSSJ	
CAB 500-C/SP5-012		YES	90.H5.50.125.0PYYDDDC HHMMSSJ	
CAB 500-C/SP7		YES	90.H5.50.007.0PYYDDDC HHMMSSJ	
CAB 500-C/SP77		YES	90.H5.50.077.0PYYDDDC HHMMSSJ	
CAB 500-C/SP10		YES	90.H5.50.010.0PYYDDDC HHMMSSJ	

Dimensions (in mm)

CAB 500-C/SP2, CAB 500-C/SP5, CAB 500-C/SP5-XXX

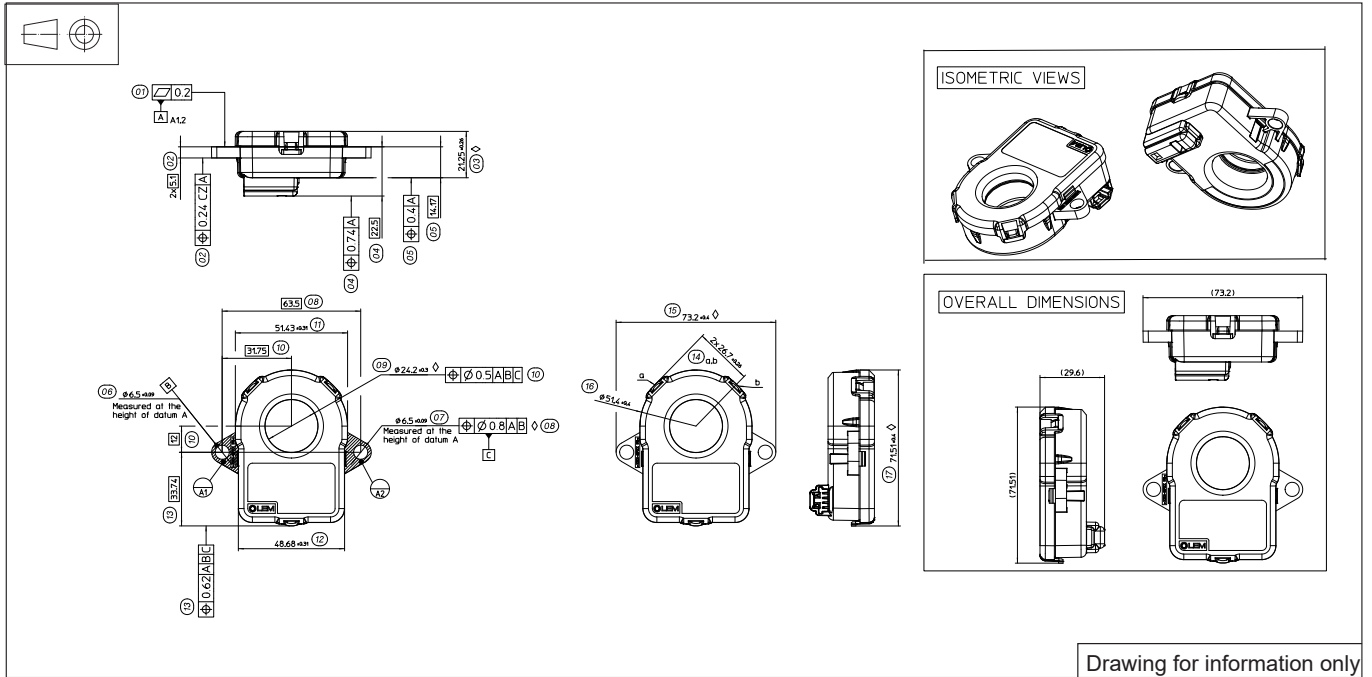

CAB 500-C/SP1, CAB 500-C/SP10

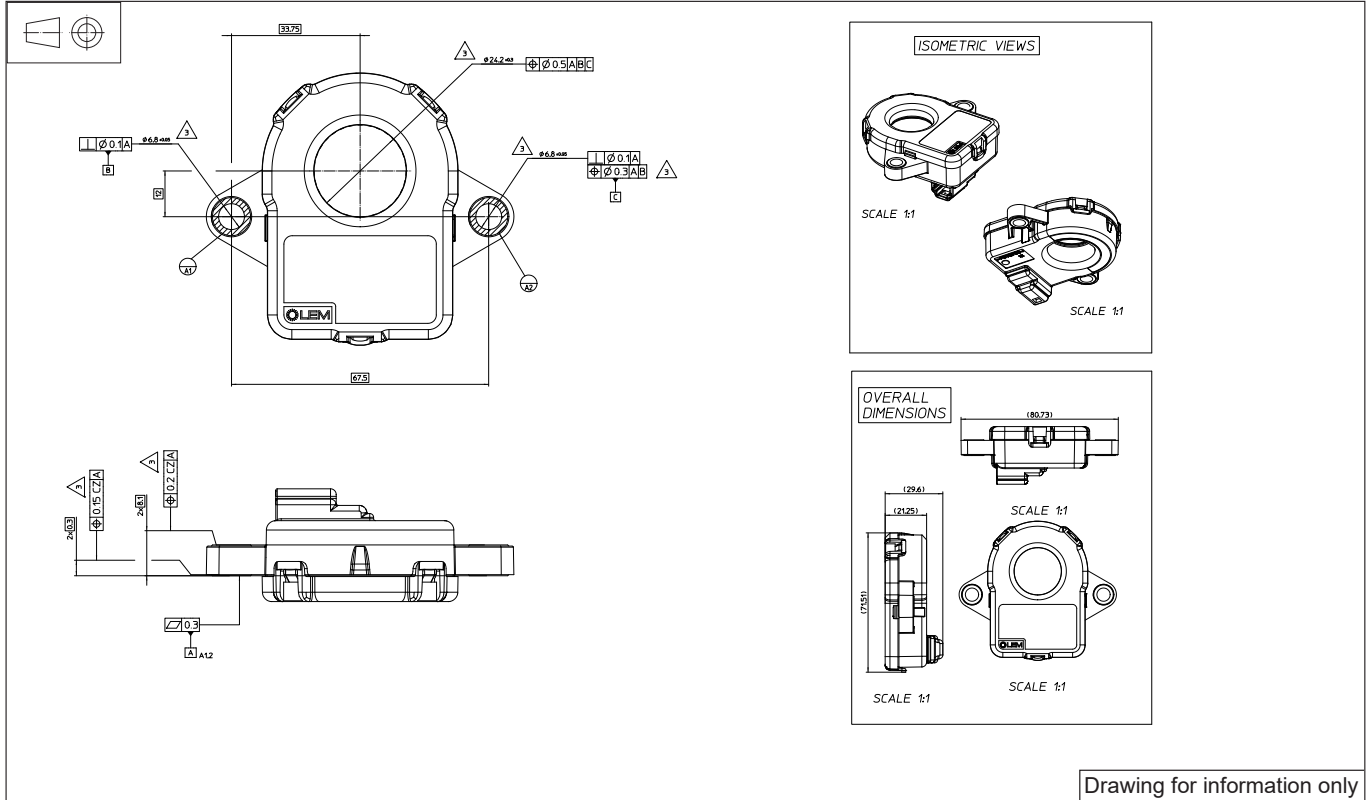

Absolute maximum ratings (not operating)

Parameter	Symbol	Unit	Specification	Conditions
Load dump overvoltage	U_C	V	32	400 ms
Over-voltage	U_C	V	24	1 minute
Reverse polarity	U_C	V	-16	1 minute
Minimum supply voltage	$U_{C\min}$	V	6	continuous, not operating
Maximum supply voltage	$U_{C\max}$	V	18	continuous, not operating
Creepage distance	d_{Cp}	mm	7.2	
Clearance	d_{Cl}	mm	6.95	
RMS voltage for AC insulation test	U_d	KV	2.5	50 Hz, 1 min
Insulation resistance	R_{INS}	MΩ	500	500 V - ISO 16750-2
IP Level			IP 42	

Characteristics in nominal range

Parameter	Symbol	Unit	Specification			Conditions
			Min	Typical	Max	
Electrical Data						
Supply voltage	U_C	V	8	13.5 ¹⁾	16	
Current consumption @ $I_p = 0$ A	I_C	mA		40	45	@ $U_C = 13.5$ V, CAN acknowledge, $T^{\circ}C$ Range
Current consumption @ $I_p = 500$ A	I_C	mA		140	160	@ $U_C = 13.5$ V, CAN acknowledge, $T^{\circ}C$ Range
Ambient operating temperature	T_A	$^{\circ}C$	-40		85	Temperature range with accuracy guaranteed ± 3 sigma
Performance Data						
Primary nominal DC	I_{PN}	A	-500		500	
Current clamping value		A	-530		530	
Voltage clamping value max		V		18		When U_C increases
				17.35		When U_C decreases
Voltage clamping value min		V		7.75		When U_C increases
				7.27		When U_C decreases
Linearity error	ε_L	%		0.1		at room temperature
Output noise		mA		± 10		
Output frequency of CAN signal ²⁾		Hz		100		Depends on the filter implemented
Start-up time	t_{start}	ms		150		
Setting time after overload		ms		20		

Notes: ¹⁾ For the classical 12 V Lead-acid battery system, the mean value of battery voltage becomes to 13.5 V during charging

²⁾ Output frequency depends on the emission period of the frame without digital filter.

Total Error Graph for all CAB 500-C Series

Performances are considered with average value over 10 CAN frames(100 ms)

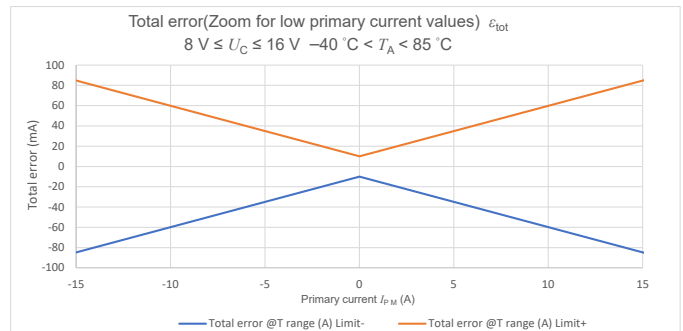
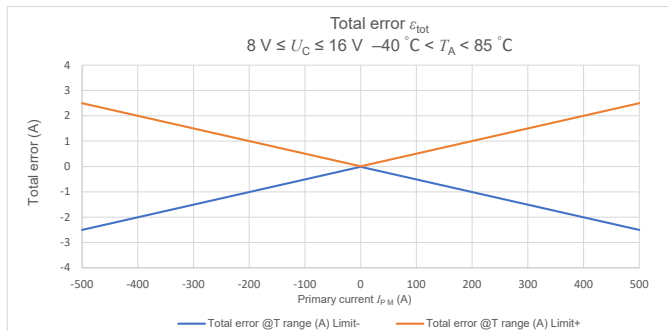
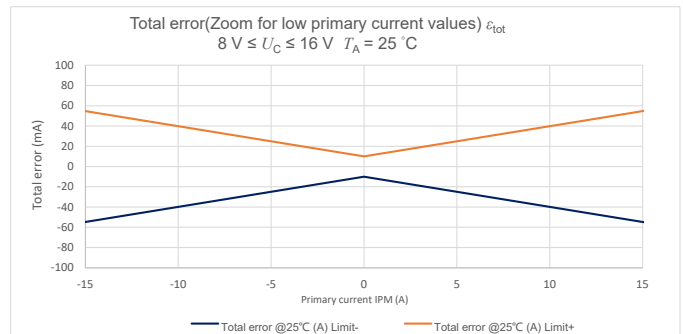
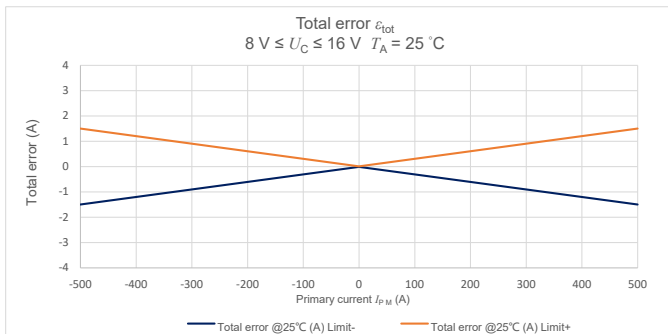

I_p (A)	Total error @ 25 °C (A)	Total error @T range (A)
-500	±1.5	±2.5
0	±0.01	±0.01
500	±1.5	±2.5

Software Version

Applicable: CAB 500-C/SP1, CAB 500-C/SP5, CAB 500-C/SP5-XXX, CAB 500-C/SP7, CAB 500-C/SP10, CAB 500-C/SP77

- CAN protocol 2.0 B
- Bit order: big endian (Motorola)
- CAN oscillator tolerance: 0.27 %
- No sleep mode capability
- 120 ohm termination resistor to be added externally (except CAB 500-C/SP5-012), internal CAN impedance = 4.8 Kohm
- CAB 500-C/SP5-012 integrates 120 ohm termination resistor inside sensor
- Refer to CAB 500 User guide for CAN modification 210208/1.

Products	CAN speed ¹⁾	CAN ID ¹⁾	Message description	Name	Data length (Nb bytes)	Type of frame	Message launch type ¹⁾
CAB 500-C/SP1 CAB 500-C/SP10	500	0x3C2	Return Current I_p (mA)	CAB 500_IP	8	Standard	Cyclic message period 10±1 ms
CAB 500-C/SP5 CAB 500-C/SP5-002	500	0x3C2					
CAB 500-C/SP5-001	250						
CAB 500-C/SP5-012	500						
CAB 500-C/SP7 CAB 500-C/SP77	500						

Signal description	Signal name	Start bit	Length
I_p Value: 80000000H=0 mA, 7FFFFFFFH=-1 mA, 80000001H=1 mA	CSM_BAT_CURRENT	24	32
Error indication (1 bit) 0=Normal 1=Failure	ERROR_INDICATION	32	1
Error information (7 bits)	CSM_FAIL	33	7
CAB5 (16 bits)	PRODUCT_NAME	48	16
Software Revision (8 bit)	SW_Revision	56	8

Note: ¹⁾ Parameters are configurable except CAB 500-C/SP1 and CAB 500-C/SP10.

Software Version
Applicable: CAB 500-C/SP2

- CAN protocol 2.0 B
- Bit order: big endian (Motorola)
- CAN oscillator tolerance: 0.27 %
- No sleep mode capability
- 120 ohms termination resistor to be added externally, internal CAN impedance = 4.8 kohm
- Choke coil on the CAN interface
- Refer to CAB 500 User guide for CAN modification 210208/1.

Message Description	CAN ID	Name	Data Length (Nb bytes)	Type of frame	Message launch type	Signal description	Signal name	Start bit	Length
Return Current I_p (mA)	0x3C2	CAB 500_IP	8	Standard	Cyclic message period 10±1 ms	I_p Value: 80000000H = 0 mA, 7FFFFFFFH = -1 mA, 80000001H = 1 mA	CSM_BAT_CURRENT	24	32
						Error indication (1 bit) 0 = Normal 1 = Failure	ERROR_INDICATION	32	1
						Error information (7 bits)	CSM_FAIL	33	7
						CAB (16 bits)	PRODUCT_NAME	48	16
						Software Revision (8 bit)	SW_Revision	56	8
Start/Stop CAN TX	0x6F0	TX_Control	8	Standard	Asynchronous received message	Set to 0x02	PCI	0	8
						0x28 (Stop CAN) / 0x29 (Start CAN)	BS	8	8
						Set to 0x02	STmin	16	8
						Set to 0xFFFF FFFF	VACANT_DATA_5 BYTES	56	40

Error Management
Applicable: CAB 500-C/SP1, CAB 500-C/SP2, CAB 500-C/SP5, CAB 500-C/SP5-XXX, CAB 500-C/SP7, CAB 500-C/SP10

Failure Mode	I_p Value	Error Indication	Error Information
Memory Error	0x FFFF FFFF	1	0x40
Overcurrent Detection $I_p >$ Approximate 580 A	0x FFFF FFFF	1	0x41
Fluxgate has no oscillation for more than 20 ms	0x FFFF FFFF	1	0x42
Supply voltage is out of range	0x FFFF FFFF	1	0x46
Hardware default ADC channel	0x FFFF FFFF	1	0x47
New Data not available	0x FFFF FFFF	1	0x49
Hardware default DAC Threshold	0x FFFF FFFF	1	0x4A
Hardware default Reference voltage	0x FFFF FFFF	1	0x4B

Applicable: CAB 500-C/SP77

Failure Mode	I_p Value	Error Indication	Error Information
Memory Error	0x FFFF FFFF	1	0x40
Overcurrent Detection $I_p >$ Approximate 660 A	0x FFFF FFFF	1	0x41
Fluxgate has no oscillation for more than 20 ms	0x FFFF FFFF	1	0x42
Supply voltage is out of range	0x FFFF FFFF	1	0x46
Hardware default ADC channel	0x FFFF FFFF	1	0x47
New Data not available	0x FFFF FFFF	1	0x49
Hardware default DAC Threshold	0x FFFF FFFF	1	0x4A
Hardware default Reference voltage	0x FFFF FFFF	1	0x4B

Applicable Standards

Test	Standard	Procedure
Environmental test		
Low Temperature Operating Endurance	ISO 16750-4 (04/2010)	120 hrs, -40 °C, power on
High Temperature Operating Endurance	ISO 16750-4 (04/2010)	85 °C, 120 hrs, power on
Powered Thermal Cycle Endurance	ISO16750-4 (04/2010)	-40 °C (20 min soak) / +85 °C (20 min soak), slope 4 °C/min, 540 cycles (936 hrs, 39 days), power supply 13.5 V
Thermal Shock	ISO 16750-4 (04/2010)	-40 °C (20 min soak) / +85 °C (20 min soak), 1000 cycles (667 h, 28 days); no power supply
Thermal Humidity Cycle	ISO 16750-4 (04/2010)	-10 °C /+65 °C, 93 % humidity, 10 cycles (240 hrs), no power supply
High Temperature and Humidity Endurance	JESD 22-A101 (03/2009)	85 °C, 85 % humidity, 1000 hrs
Vibration	ISO 16750-3 (12/2012)	Test IV, -40 °C / +85 °C during 8 hrs (Fig.1), RMS acceleration 27.1 m/s ² , 20 h / axis, 3 axis+, power on and output monitoring
Mechanical Shock	ISO16750-3 (12/2012)	500 m/s ² , 10 each direction (60 total), Half sine pulse
Handling Drop (Free Fall)	ISO16750-3 (12/2012)	2 falls per DUT, 3 axis, total 6 falls, from 1 meter on concrete floor
Water Intrusion	DIN 40050-9 (1993-05)	IPx2, flow 3 (+0.5/0) mm/min, 10 mins, connector downward, parts inclined at 15°
Dust (and other solid intrusion)	DIN 40050-9 (1993-05)	IP4x, The rigid stem, 1 mm diameter, is pressed against the casing of the part with a 1N force Vertical flow chamber, Portland cement, 2 kg/m ³ , 6 s ON/15 min OFF for 20 cycles, parts inclined at 15°
Mixed Flowing Gas	IEC60068-2-60 (12/1996)	Mehod4 in Table1, H2S, NO2, Cl2, SO2, 25 ±1 °C, RH 75 ±3 %, 21 days
Salt Fog	NISSAN M0158(2009) / M0140(2014)	NaCl 50 g/L, Cycle: salt spray 4 hrs, dry 2 hrs with 60 °C < 30 % RH, moistening 2 hrs with 50 °C 95 % RH, 110 cycles
EMC test		
Conducted emission- Voltage method	CISPR 25 (03/2008)	9 kHz to 110 MHz, Class 3
Conducted emission- Current method	CISPR 25 (03/2008)	20 Hz to 110 MHz, Class 3
Emission Radiated (ALSE)	CISPR 25 (03/2008)	0.1 MHz to 5 GHz, Class 3
IMMUNITY TO CURRENT INJECTION (BCI)	ISO 11452-4 (12/2011)	Test level II and Test level IV AnnexE TableE.1
Immunity to Radiated field- Anechoic chamber(ALSE)	ISO 11452-2 (11/2004)	Test frequency: 80 MHz-3.2 GHz, Test level: 100 V/m 200 V/m
Low frequency magnetic field immunity	ISO 11452-8 (06/2015)	0.05 kHz to 200 kHz
RESISTANCE TO PULSES 1, 2A,2B (Transient Disturbance conducted along supply line)	ISO 7637-2 §5.6 (2004)	1: $U_s = -100$ V pulse number = 500; 2a: $U_s = +37$ V pulse number = 500; 2b: $U_s = +10$ V pulse number = 10.

Test	Standard	Procedure
Resistance to pulses 3a & 3b (Transient Disturbance conducted along supply line)	ISO 7637-2 §5.6 (2004)	3a: $U_s = -150$ V pulse time = 10 min; 3b: $U_s = 100$ V pulse time = 10 min
Resistance to pulses 4 (Transient Disturbance conducted along supply line)	ISO 7637-2 §5.6 (2004)	4: $U_s = -6$ V $U_a = -2.5$ Number of pulse = 1
Load Dump Resistance to 5b pulses. (Transient Disturbance conducted along supply line)	ISO 7637-2 §5.6 (2004)	5b: $U_s = 30$ V $U_s = 21.5$ V Number of pulse = 5
Transient disturbance conducted along i/o or sensor lines	ISO 7637-3 (2007)	Fast a: CCC -150 V 10 min; Fast b: CCC $+100$ V 10 min slow pulse positive: ICC $+20$ V 20 min; slow pulse negative: ICC -20 V 20 min
ESD Handing test	ISO 10605 (2008)	Unpowered, pins: ± 4 kV, housing: ± 8 kV, air: ± 15 kV and ± 30 kV
ESD Operating test	ISO 10605 (2008)	Powered, indirect contact discharge: ± 4 kV ± 8 kV ± 15 kV ± 25 kV, air: ± 8 kV ± 20 kV
Electrical test		
Direct current supply voltage	ISO 16750-2 §4.2 (11/2012)	Code B
Overvoltage	ISO 16750-2 §4.3.1 (11/2012)	18 V, 1 h, @ 65 °C ; 24 V, 1 min, @ 25 °C
Superimposed Alternating Voltage	ISO 16750-2 §4.4 (11/2012)	Severity2: $U_{pp} = 4$ V, Servery4: $U_{pp} = 2$ V
Resistance to slow decrease and increase of supply voltage	ISO 16750-2 §4.5 (11/2012)	$U_{min} = 8$ V, 0.5 V/mim, Run DUT 10 min
Momentary drop in supply voltage	ISO 16750-2 §4.6.1 (11/2012)	Room temperature, U_{Smin} to 4.5 V
Resistance to power supply micro interruption	Renault 36-00-808 6.1.10	14 V to 0 V, 10 us (Class A), 100 us (Class B), 5 ms (Class B), 50 ms (Class C), 300 ms (Class C)
Reset behaviour at voltage drop	ISO 16750-2 §4.6.2 (11/2012)	$U_{Smin} = 8$ V
Starting profile	ISO 16750-2 §4.6.3 (11/2012)	System with 12 V nominal voltage Level I
Reverse voltage	ISO 16750-2 §4.7 (11/2012)	Case 2
Ground reference and supply offset	ISO 16750-2 §4.8 (11/2012)	Offset voltage = 1.0 ± 0.1 V
Open Circuit	ISO 16750-2 §4.9 (11/2012)	Single line / Multiple line interruption
Short circuit protection	ISO 16750-2 §4.10.2 (11/2012)	Signal circuits, $U_{Smax} = 16$ V and GND, duration 60 s

Installation influence

Overview

The CAB 500-C family uses a very accurate technology and offers the customers the current measurement needed to the application. In order to respect this accuracy, some conditions must be respected during the design of the environment of the sensor:

- Primary busbar centering
- Bus-bar shape
- Contactors position



The busbar dimension for test:
20 mm(W)x3 mm(H).
Environment: room temperature.



Due to the complexity of practical application, the examples cannot cover all the application conditions.



It can be reference during BDU design, but the performance validation of BDU is necessary.



The sensor has different performance on different angles. For details or any further questions, please contact LEM Technical Customer Support.

Return busbar type definition

Explanation: Recommended / Case of accuracy close to the limit / Not recommended

S-shape busbar recommendation																			
		<table border="1"> <thead> <tr> <th>a(mm)</th> <th>A</th> <th>B</th> <th>C</th> <th>D</th> </tr> </thead> <tbody> <tr> <td>10</td> <td style="color: orange;">A</td> <td style="color: orange;">B</td> <td style="color: orange;">C</td> <td style="color: orange;">D</td> </tr> <tr> <td>>10</td> <td style="color: green;">A</td> <td style="color: green;">B</td> <td style="color: green;">C</td> <td style="color: green;">D</td> </tr> </tbody> </table>			a(mm)	A	B	C	D	10	A	B	C	D	>10	A	B	C	D
a(mm)	A	B	C	D															
10	A	B	C	D															
>10	A	B	C	D															
L-shape busbar recommendation																			
		<table border="1"> <thead> <tr> <th>a(mm)</th> <th>A</th> <th>B</th> <th>C</th> <th>D</th> </tr> </thead> <tbody> <tr> <td>10</td> <td style="color: orange;">A</td> <td style="color: orange;">B</td> <td style="color: orange;">C</td> <td style="color: orange;">D</td> </tr> <tr> <td>>10</td> <td style="color: green;">A</td> <td style="color: green;">B</td> <td style="color: green;">C</td> <td style="color: green;">D</td> </tr> </tbody> </table>			a(mm)	A	B	C	D	10	A	B	C	D	>10	A	B	C	D
a(mm)	A	B	C	D															
10	A	B	C	D															
>10	A	B	C	D															
		<table border="1"> <thead> <tr> <th>a(mm)</th> <th>A</th> <th>B</th> <th>C</th> <th>D</th> </tr> </thead> <tbody> <tr> <td>10</td> <td style="color: orange;">A</td> <td style="color: orange;">B</td> <td style="color: orange;">C</td> <td style="color: orange;">D</td> </tr> <tr> <td>>10</td> <td style="color: green;">A</td> <td style="color: green;">B</td> <td style="color: green;">C</td> <td style="color: green;">D</td> </tr> </tbody> </table>			a(mm)	A	B	C	D	10	A	B	C	D	>10	A	B	C	D
a(mm)	A	B	C	D															
10	A	B	C	D															
>10	A	B	C	D															

U1-shape busbar recommendation

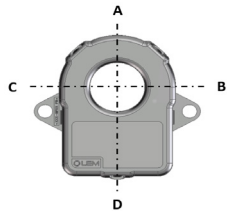
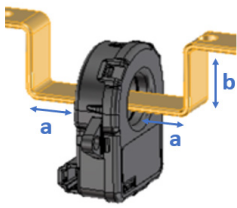

b(mm)	a(mm)					
	10		20		30	
40	A	B	A	B	A	B
	C	D	C	D	C	D
50	A	B	A	B	A	B
	C	D	C	D	C	D
60	A	B	A	B	A	B
	C	D	C	D	C	D

U2-shape busbar recommendation

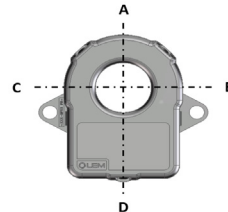
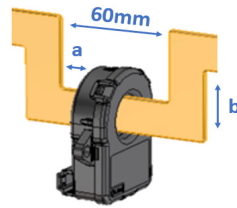

b(mm)	a(mm)					
	10		20		30	
40	A	B	A	B	A	B
	C	D	C	D	C	D
50	A	B	A	B	A	B
	C	D	C	D	C	D

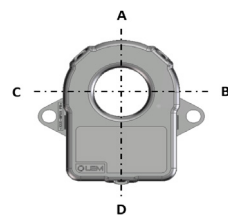
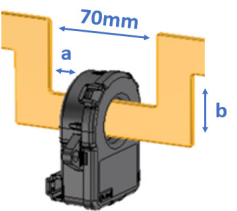

b(mm)	a(mm)							
	10		20		30		40	
50	A	B	A	B	A	B	A	B
	C	D	C	D	C	D	C	D

U3-shape busbar recommendation

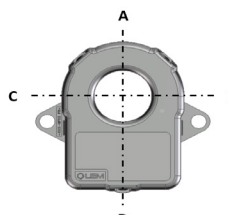
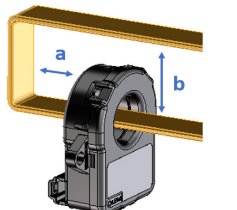

b(mm)	a(mm)											
	20		30		40		50		60			
70	A	B	A	B	A	B	A	B	A	B		
	C	D	C	D	C	D	C	D	C	D		
80	A	B	A	B	A	B	A	B	A	B		
	C	D	C	D	C	D	C	D	C	D		
90	A	B	A	B	A	B	A	B	A	B		
	C	D	C	D	C	D	C	D	C	D		
100	A	B	A	B	A	B	A	B	A	B		
	C	D	C	D	C	D	C	D	C	D		

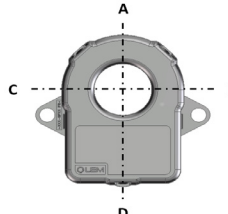
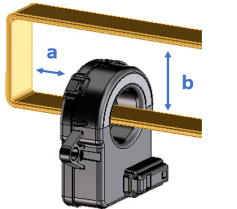

b(mm)	a(mm)									
	20		30		40		50		60	
70	A	B	A	B	A	B	A	B	A	B
	C	D	C	D	C	D	C	D	C	D
80	A	B	A	B	A	B	A	B	A	B
	C	D	C	D	C	D	C	D	C	D
90	A	B	A	B	A	B	A	B	A	B
	C	D	C	D	C	D	C	D	C	D
100	A	B	A	B	A	B	A	B	A	B
	C	D	C	D	C	D	C	D	C	D

U4-shape busbar recommendation

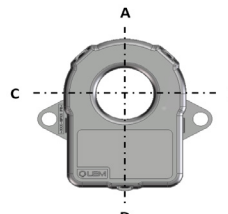
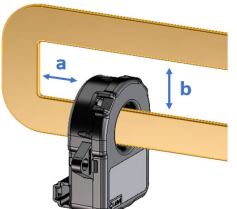

b(mm)	a(mm)							
	20		30		40		50	
70	A	B	A	B	A	B	A	B
	C	D	C	D	C	D	C	D
80	A	B	A	B	A	B	A	B
	C	D	C	D	C	D	C	D
90	A	B	A	B	A	B	A	B
	C	D	C	D	C	D	C	D
100	A	B	A	B	A	B	A	B
	C	D	C	D	C	D	C	D

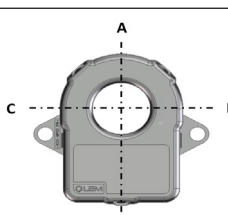
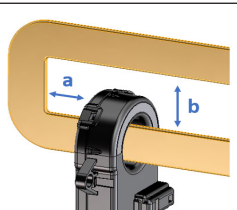

b(mm)	a(mm)							
	20		30		40		50	
70	A	B	A	B	A	B	A	B
	C	D	C	D	C	D	C	D
80	A	B	A	B	A	B	A	B
	C	D	C	D	C	D	C	D
90	A	B	A	B	A	B	A	B
	C	D	C	D	C	D	C	D
100	A	B	A	B	A	B	A	B
	C	D	C	D	C	D	C	D

IMPORTANT NOTICE

The information in this document is considered accurate and reliable. However, LEM International SA and any company directly or indirectly controlled by LEM Holding SA ("LEM") do not provide any guarantee or warranty, expressed or implied, regarding the accuracy or completeness of this information and are not liable for any consequences resulting from its use. LEM shall not be responsible for any indirect, incidental, punitive, special, or consequential damages (including, but not limited to, lost profits, lost savings, business interruption, costs related to the removal or replacement of products, or rework charges) regardless of whether such damages arise from tort (including negligence), warranty, breach of contract, or any other legal theory.

LEM reserves the right to update the information in this document, including specifications and product descriptions, at any time without prior notice. Information in this document replaces any previous versions of this document. No license to any intellectual property is granted by LEM through this document, either explicitly or implicitly. Any Information and product described herein is subject to export control regulations.

LEM products may possess either unidentified or documented vulnerabilities. It is the sole responsibility of the purchaser to design and operate their applications and products in a manner that mitigates the impact of these vulnerabilities. LEM disclaims any liability for such vulnerabilities. Customers must select products with security features that best comply with applicable rules, regulations, and standards for their intended use. The purchaser is responsible for making final design decisions regarding its products and for ensuring compliance with all legal, regulatory, and security-related requirements, irrespective of any information or support provided by LEM.

LEM products are not intended, authorized, or warranted for use in life support, life-critical, or safety-critical systems or equipment, nor in applications where failure or malfunction of an LEM product could result in personal injury, death, or significant property or environmental damage. LEM and its suppliers do not assume liability for the inclusion and/or use of LEM products in such equipment or applications; thus, this inclusion and/or use is at the purchaser's own and sole risk. Unless explicitly stated that a specific LEM product is automotive qualified, it should not be used in automotive applications. LEM does not accept liability for the inclusion and/or use of non-automotive qualified products in automotive equipment or applications.

Applications that are described herein are for illustrative purposes only. LEM makes no representation or warranty that LEM products will be suitable for a particular purpose, a specified use or application. The purchaser is solely responsible for the design and operation of its applications and devices using LEM products, and LEM accepts no liability for any assistance with any application or purchaser product design. It is purchaser's sole responsibility to determine whether the LEM product is suitable and fit for the purchaser's applications and products planned, as well as for the planned application and use of purchaser's third-party customer(s).

Stressing and using LEM products at or above limiting values will cause permanent damage to the LEM product and potentially to any device embedding or operating with LEM product. Limiting values are stress ratings only and operation of the LEM product at or above conditions and limits given in this document is not warranted. Continuous or repeated exposure to limiting values will permanently and irreversibly affect the quality and reliability of the LEM product.

LEM products are sold subject to the general terms and conditions of commercial sale, as published at www.lem.com unless otherwise agreed in a specific written agreement. LEM hereby expressly rejects the purchaser's general terms and conditions for purchasing LEM products by purchaser. Any terms and conditions contained in any document issued by the purchaser either before or after issuance of any document by LEM containing or referring to the general terms and conditions of sale are explicitly rejected and disregarded by LEM, and the document issued by the purchaser is wholly inapplicable to any sale or licensing made by LEM and is not binding in any way on LEM.

© 2025 LEM INTERNATIONAL SA – All rights reserved