

Voltage Transducer DV 6400

$$U_{PN} = 6400 \text{ V}$$

For the electronic measurement of voltage: DC, AC, pulsed..., with galvanic separation between the primary and the secondary circuit.

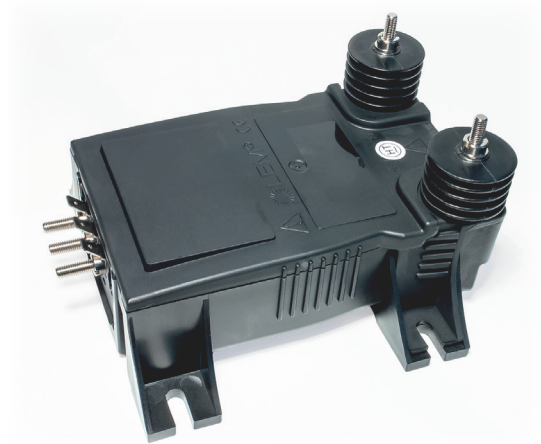

Features

- Bipolar and insulated voltage measurement up to 7360 V peak
- Current output
- Footprint compatible with OV, CV4 series and LV 200-AW/2 families.
- Primary input on M5 threaded studs
- Secondary output on Faston and M5 threaded studs + Safety nuts
- Primary on the top.

Advantages

- Low consumption and losses
- Compact design
- Good behaviour under common mode variations
- Excellent accuracy (offset, sensitivity, linearity)
- Delay time 60 μ s
- Low temperature drift
- High immunity to external interferences.

Applications

- Single or three phase inverters
- Propulsion and braking choppers
- Propulsion converters
- Auxiliary converters
- High power drives
- Substations
- On-board energy meters
- Energy metering.

Standards

- EN 50155: 2021
- EN 50124-1: 2017
- EN 50121-3-2: 2016.

Application Domain

- Railway (fixed installations and onboard).

Absolute maximum ratings

Parameter	Symbol	Value
Maximum supply voltage ($U_p = 0$ V, 0.1 s) =	$\pm \hat{U}_{C \max}$	± 34 V
Maximum supply voltage (working) (-40 ... 70 °C) =	$\pm U_{C \max}$	± 26.4 V
Maximum primary voltage (-40 ... 70 °C)	$U_{P \max}$	7360 V
Maximum steady state primary voltage (-40 ... 70 °C)	$U_{PN \max}$	6400 V
Maximum DC common mode voltage	$U_{HV+} + U_{HV-}$ and $ U_{HV+} - U_{HV-} $	≤ 7000 V

Absolute maximum ratings apply at 25 °C unless otherwise noted.
 Stresses above these ratings may cause permanent damage.
 Exposure to absolute maximum ratings for extended periods may degrade reliability.

Environmental and mechanical characteristics

Parameter	Symbol	Unit	Min	Typ	Max	Comment
Ambient operating temperature	T_A	°C	-40		70	
Ambient storage temperature	$T_{A \text{st}}$	°C	-50		85	
Equipment operating temperature class						EN 50155: OT6
Switch-on extended operating temperature class						EN 50155: ST0
Rapid temperature variation class						EN 50155: H2
Conformal coating type						EN 50155: PC2
Relative humidity	RH	%			95	
Shock & vibration category and class						EN 50155: 1B, (EN 61373)
Mass	m	g		655		
Ingress protection rating				IP40		IEC 60529 by construction (Indoor use)
Pollution degree					PD4	Insulation voltage accordingly
Altitude		m			2000 ¹⁾	

Note: ¹⁾ Insulation coordination at 2000 m.

RAMS data

Parameter	Symbol	Unit	Min	Typ	Max	Comment
Useful life class						EN 50155: L4
Mean failure rate	$\bar{\lambda}$	h ⁻¹		1/1883371		According to IEC 62380 $T_A = 45$ °C ON: 20 hrs/day ON/OFF: 320 cycles/year $U_c = \pm 24$ V, $U_p = 6400$ V

Insulation coordination

Parameter	Symbol	Unit	Value	Comment
RMS voltage for AC insulation test, 50 Hz, 1 min	U_d	kV	18.5	100 % tested in production
Impulse withstand voltage 1.2/50 μ s	U_{Ni}	kV	30	
Partial discharge extinction test voltage ($q_m < 10$ pC)	U_t	V	7050	
Insulation resistance	R_{INS}	M Ω	200	Measured at 500 V DC
Clearance (pri. - sec.)	d_{Cl}	mm	see dimensions drawing on page 10	Shortest distance through air
Creepage distance (pri. - sec.)	d_{Cp}	mm		Shortest path along device body
Case material	-	-	V0	According to UL 94
Comparative tracking index	CTI		600	

Electrical data

At $T_A = 25\text{ °C}$, $\pm U_C = \pm 24\text{ V}$, $R_M = 100\ \Omega$, unless otherwise noted. (see Definition of typical, minimum and maximum values paragraph in [page 5](#)).
 Lines with a * in the conditions column apply over the $-40 \dots 70\text{ °C}$ ambient temperature range.

Parameter	Symbol	Unit	Min	Typ	Max	Conditions
Primary nominal DC voltage (continuous)	U_{PNDC}	V			6400	*
Primary nominal AC RMS voltage (continuous)	U_{PNAC}	V			5204	*
Primary voltage, measuring range	U_{PM}	V	-7360		7360	*
Measuring resistance	R_M	Ω	0		183	* For $ U_{PM} < 7360\text{ V}$, max value of R_M is given on figure 1
Secondary nominal DC current (continuous)	$I_{SND C}$	mA			50	*
Secondary current limit	I_{SL}	mA			57.5	*
Supply voltage =	$\pm U_C$	V	± 13.5	± 24	± 26.4	*
Rise time of U_C (10-90 %)	t_{rise}	ms			100	
Current consumption =	I_C	mA		$20 + I_S$	$25 + I_S$	@ $U_C = \pm 24\text{ V}$ at $U_p = 0\text{ V}$
Inrush current						NA (EN 50155)
Interruptions on power supply voltage class						NA (EN 50155)
Supply change-over class						NA (EN 50155)
Electrical Offset current	I_{OE}	μA	-50	0	50	100 % tested in production
Temperature variation of $I_o @ U_p = 0$	I_{OT}	μA	-80 -100		80 100	* -25 ... 70 °C -40 ... 70 °C, 100 % tested in production
Sensitivity	S	$\mu\text{A/V}$		7.8125		50 mA for 6400 V
Sensitivity error	ϵ_s	%	-0.2	0	0.2	100 % tested in production
Temperature variation of sensitivity error	ϵ_{ST}	%	-0.5 -0.8		0.5 0.8	* -25 ... 70 °C -40 ... 70 °C
Linearity error	ϵ_L	% of U_{PM}	-0.1		0.1	* $\pm 7360\text{ V}$ range
Total error	ϵ_{tot}	% of U_{PN}	-0.3 -0.7 -1		0.3 0.7 1	* 25 °C; 100 % tested in production -25 ... 70 °C -40 ... 70 °C
RMS noise current	I_{no}	μA		10		1 Hz to 100 kHz
Delay time @ 10 % of the final output value U_{PN} step	t_{D10}	μs		21		
Delay time @ 90 % of the final output value U_{PN} step	t_{D90}	μs		48	60	0 to 6400 V step, 6 kV/ μs
Frequency bandwidth	BW	kHz		12 6.5 1.6		-3 dB -1 dB -0.1 dB
Start-up time	t_{start}	ms		190	250	*
Resistance of primary (winding)	R_p	M Ω		23		*
Total primary power loss @ U_{PN}	P_p	W		1.78		*

Definition of typical, minimum and maximum values

Minimum and maximum values for specified limiting and safety conditions have to be understood as such as well as values shown in “typical” graphs.

On the other hand, measured values are part of a statistical distribution that can be specified by an interval with upper and lower limits and a probability for measured values to lie within this interval.

Unless otherwise stated (e.g. “100 % tested”), the LEM definition for such intervals designated with “min” and “max” is that the probability for values of samples to lie in this interval is 99.73 %.

For a normal (Gaussian) distribution, this corresponds to an interval between -3 sigma and $+3$ sigma. If “typical” values are not obviously mean or average values, those values are defined to delimit intervals with a probability of 68.27 %, corresponding to an interval between $-\text{sigma}$ and $+\text{sigma}$ for a normal distribution.

Typical, maximal and minimal values are determined during the initial characterization of the product.

Typical performance characteristics

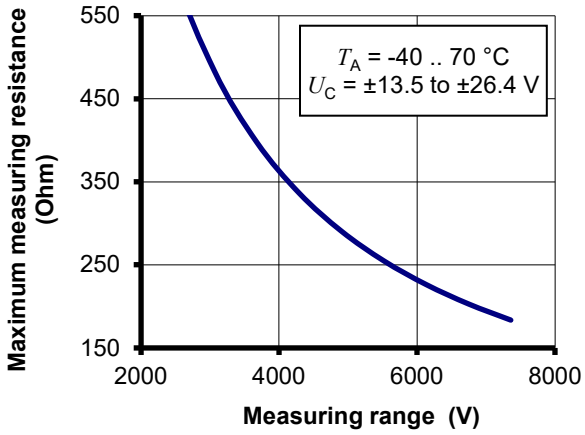

Figure 1: Maximum measuring resistance

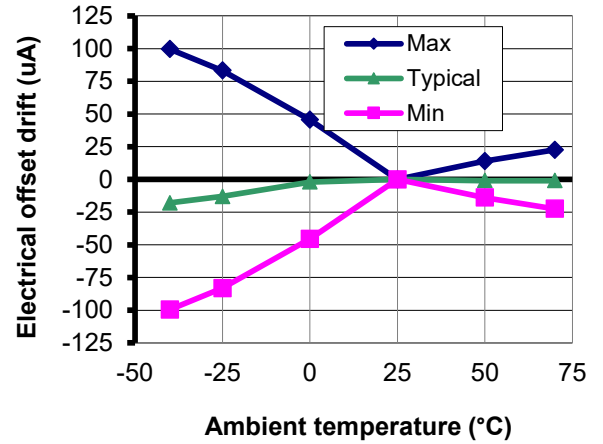

Figure 2: Electrical offset thermal drift

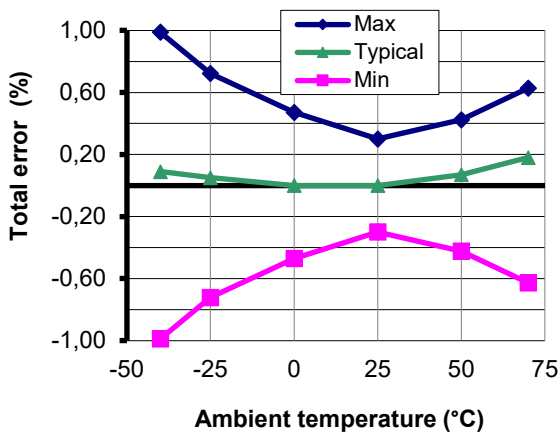

Figure 3: Total error in temperature

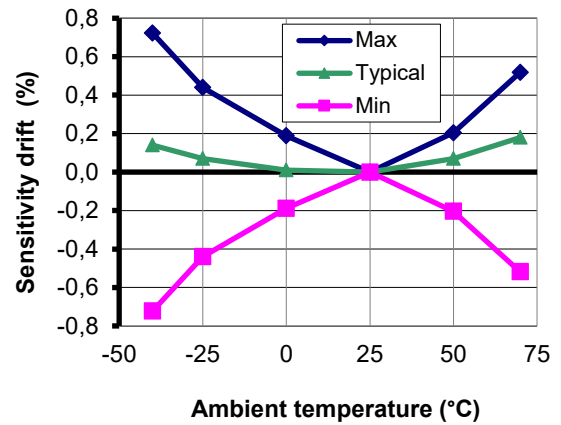

Figure 4: Sensitivity thermal drift

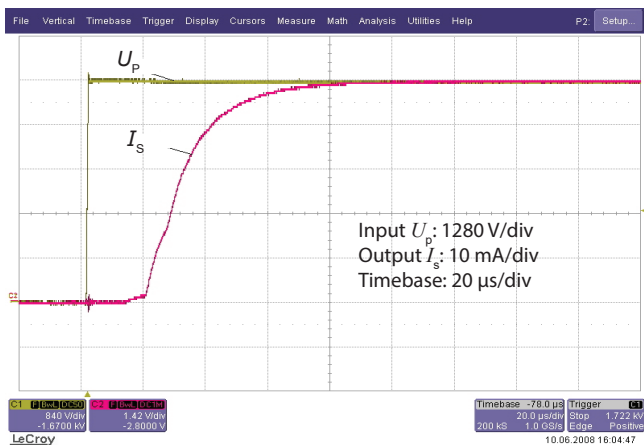

Figure 5: Typical step response (0 to 6400 V)

Typical performance characteristics continued

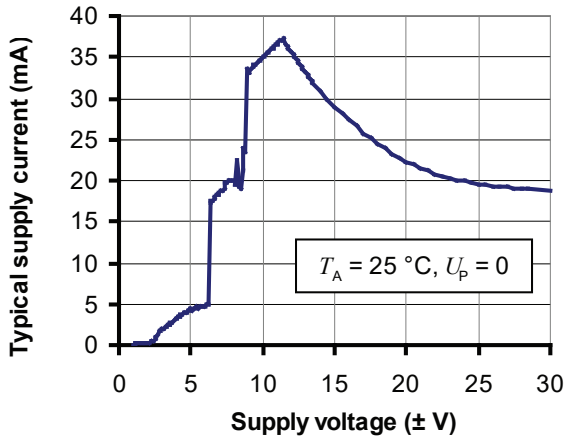

Figure 6: Supply current function of supply voltage

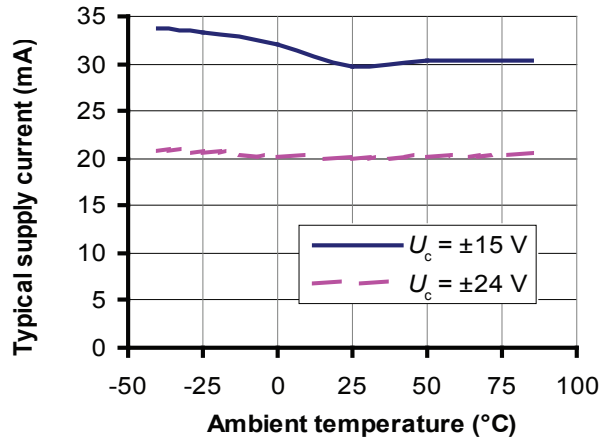

Figure 7: Supply current function of temperature

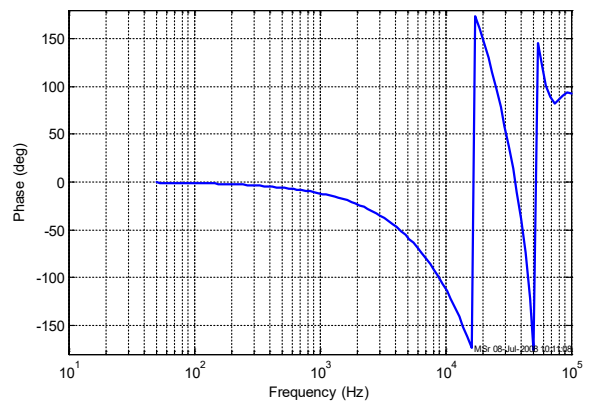
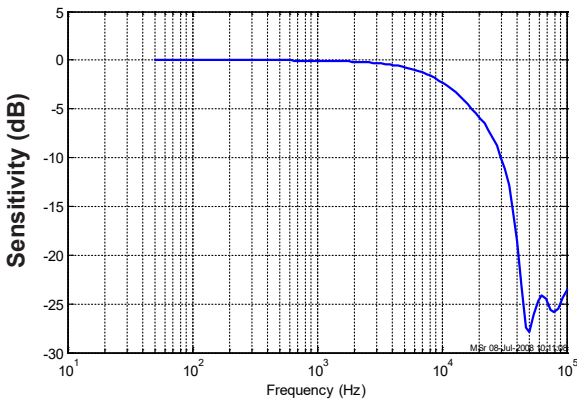

Figure 8 and 9: Typical frequency response

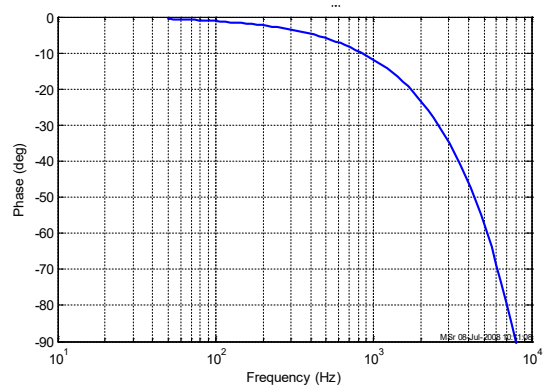
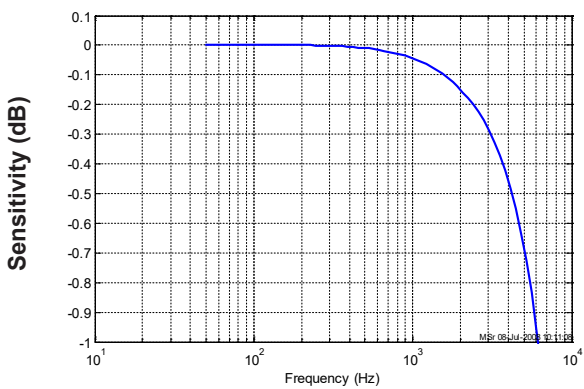

Figure 10 and 11: Typical frequency response (detail)

Typical performance characteristics continued

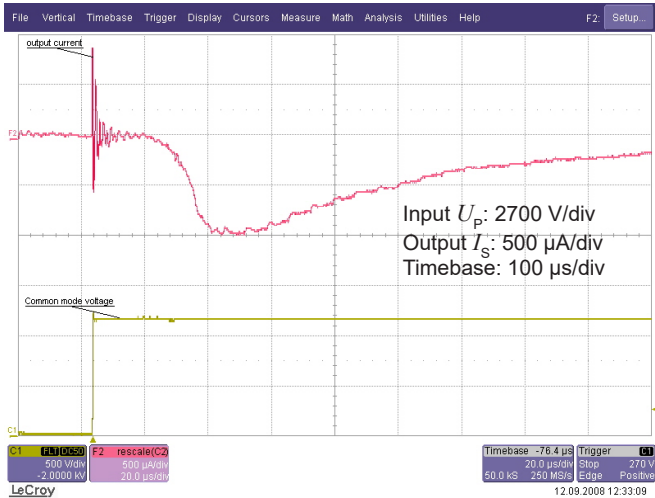

Figure 12: Typical common mode perturbation (6400 V step with 6 kV/µs, $R_M = 100 \Omega$)

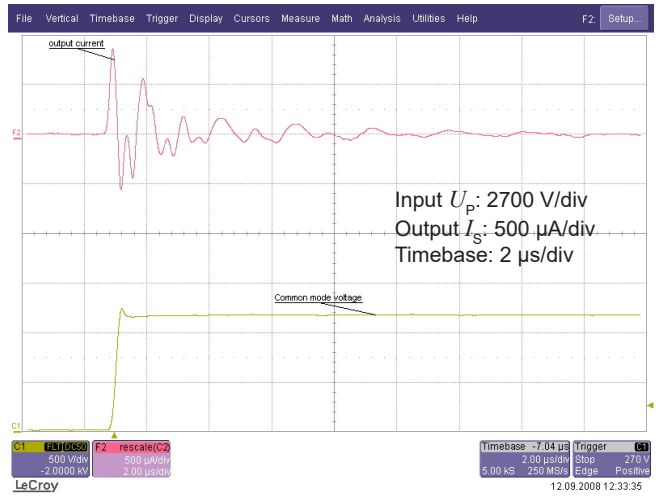

Figure 13: Detail of typical common mode perturbation (6400 V step with 6 kV/µs, $R_M = 100 \Omega$)

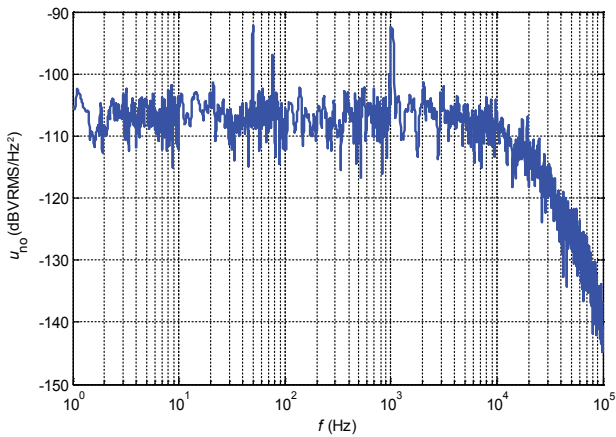

Figure 14: Typical noise voltage spectral density referred to primary with $R_M = 50 \Omega$

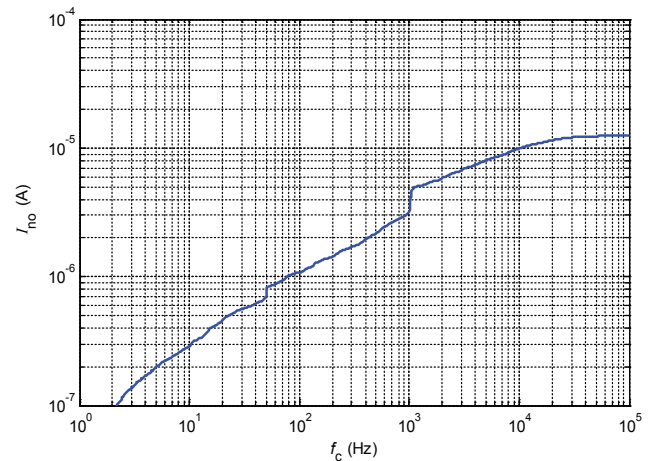

Figure 15: Typical total RMS noise current with $R_M = 50 \Omega$ (f_c is upper cut off frequency of band pass, low cut off frequency is 1 Hz)

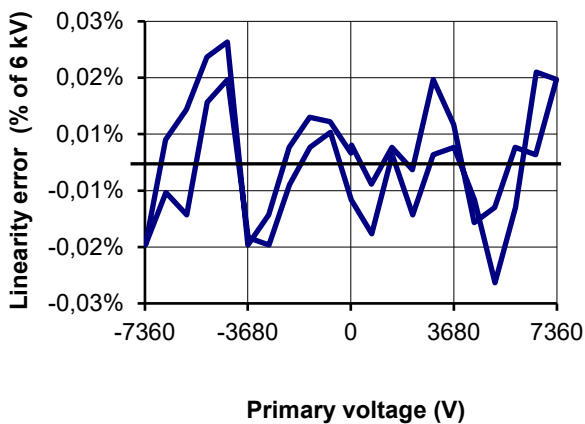

Figure 16: Typical linearity error

Figure 14 (noise voltage spectral density) shows that there are no significant discrete frequencies in the output. Figure 15 confirms the absence of steps in the total RMS noise current that would indicate discrete frequencies. To calculate the noise in a frequency band $f1$ to $f2$, the formula is:

$$I_{no}(f1 \text{ to } f2) = \sqrt{I_{no}(f2)^2 - I_{no}(f1)^2}$$

with $I_{no}(f)$ read from figure 15 (typical, RMS value).

Example:

What is the noise from 10 to 100 Hz?

Figure 15 gives $I_{no}(10 \text{ Hz}) = 0.32 \mu\text{A}$ and $I_{no}(100 \text{ Hz}) = 1 \mu\text{A}$. The RMS current noise is therefore.

$$\sqrt{(1 \times 10^{-6})^2 - (0.32 \times 10^{-6})^2} = 0.95 \mu\text{A}$$

Performance parameters definition

The schematic used to measure all electrical parameters are:

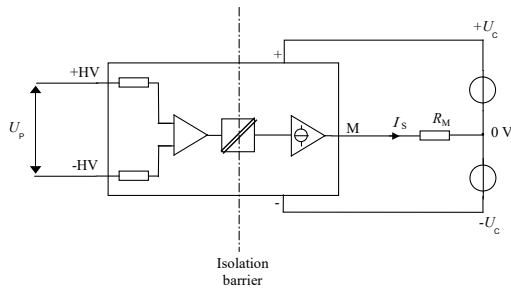

Figure 17: standard characterization schematics for current output transducers ($R_M = 50 \Omega$ unless otherwise noted)

Transducer simplified model

The static model of the transducer at temperature T_A is:

$$I_S = S \cdot U_p + \varepsilon$$

In which

$$\varepsilon = I_{OE} + I_{OT}(T_A) + \varepsilon_S \cdot S \cdot U_p + \varepsilon_{ST}(T_A) \cdot S \cdot U_p + \varepsilon_L \cdot S \cdot U_{PM}$$

- I_S : secondary current (A)
- S : sensitivity of the transducer ($\mu A/V$)
- U_p : primary voltage (V)
- U_{PM} : primary voltage, measuring range (V)
- T_A : ambient operating temperature ($^{\circ}C$)
- I_{OE} : electrical offset current (A)
- $I_{OT}(T_A)$: temperature variation of I_O at temperature T_A (μA)
- ε_S : sensitivity error at $25^{\circ}C$
- $\varepsilon_{ST}(T_A)$: thermal drift of sensitivity error at temperature T_A
- ε_L : linearity error

This is the absolute maximum error. As all errors are independent, a more realistic way to calculate the error would be to use the following formula:

$$\varepsilon = \sqrt{\sum_{i=1}^N \varepsilon_i^2}$$

Sensitivity and linearity

To measure sensitivity and linearity, the primary voltage (DC) is cycled from 0 to U_{PM} , then to $-U_{PM}$ and back to 0 (equally spaced $U_{PM}/10$ steps).

The sensitivity S is defined as the slope of the linear regression line for a cycle between $\pm U_{PM}$.

The linearity error ε_L is the maximum positive or negative difference between the measured points and the linear regression line, expressed in % of the maximum measured value.

Electrical offset

The electrical offset current I_{OE} is the residual output current when the input voltage is zero.

The temperature variation I_{OT} of the electrical offset current I_{OE} is the variation of the electrical offset from $25^{\circ}C$ to the considered temperature.

Total error

The total error ε_{tot} is the error at $\pm U_{PN}$, relative to the rated value U_{PN} .

It includes all errors mentioned above.

Delay times

The delay time $t_{D,10}$ @ 10 % and the delay time $t_{D,90}$ @ 90 % with respect to the primary are shown in the next figure.

Both slightly depend on the primary voltage dv/dt . They are measured at nominal voltage.

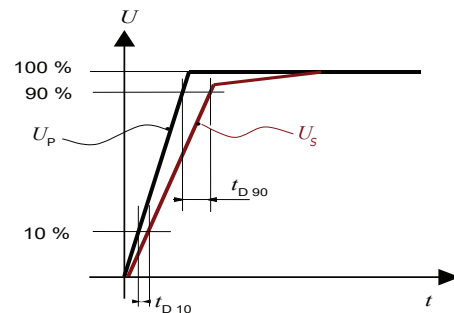
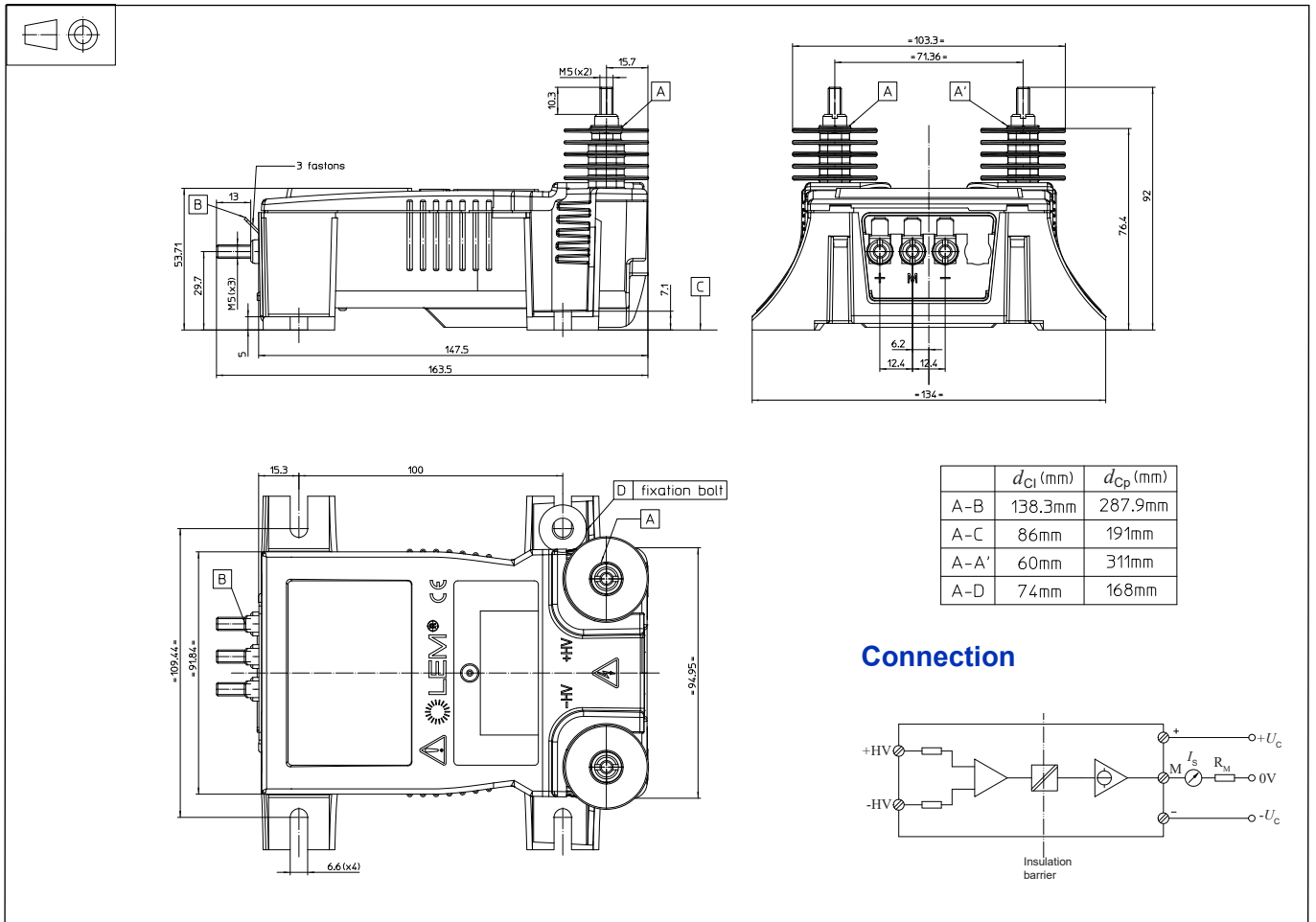
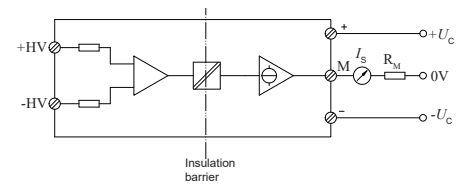

Figure 18: delay time $t_{D,10}$ @ 10 % and delay time $t_{D,90}$ @ 90 %.

Dimensions (in mm)



Connection



Mechanical characteristics

- General tolerance ± 1 mm
- Transducer fastening
 - 4 M6 steel screws
 - 4 washers of ext. \varnothing 18 mm
- Recommended fastening torque 5 N·m
- Connection of primary
 - M5 threaded studs
 - Recommended fastening torque 2.2 N·m
- Connection of secondary
 - 6.3 x 0.8 mm Faston and 5 threaded studs
 - Recommended fastening torque 2.2 N·m

Remarks

- I_s is positive when a positive voltage is applied on +HV.
- The transducer is directly connected to the primary voltage.
- The primary cables have to be routed together all the way.
- The secondary cables also have to be routed together all the way.
- Installation of the transducer is to be done without primary or secondary voltage present
- Installation of the transducer must be done unless otherwise specified on the datasheet, according to LEM Transducer Generic Mounting Rules. Please refer to LEM document N°ANE120504 available on our Web site: <https://www.lem.com/en/file/3137/download/>.

Note: Additional information available on request.

Safety

This transducer must be used in limited-energy secondary circuits according to IEC 61010-1.



This transducer must be used in electric/electronic equipment with respect to applicable standards and safety requirements in accordance with the manufacturer's operating instructions.



Caution, risk of electrical shock

When operating the transducer, certain parts of the module can carry hazardous voltage (e.g. primary connections, power supply). Ignoring this warning can lead to injury and/or cause serious damage. This transducer is a built-in device, whose conducting parts must be inaccessible after installation. A protective housing or additional shield could be used. Main supply must be able to be disconnected.