

For the electronic measurement of current: DC, AC, pulsed..., with galvanic separation between the primary and the secondary circuit.

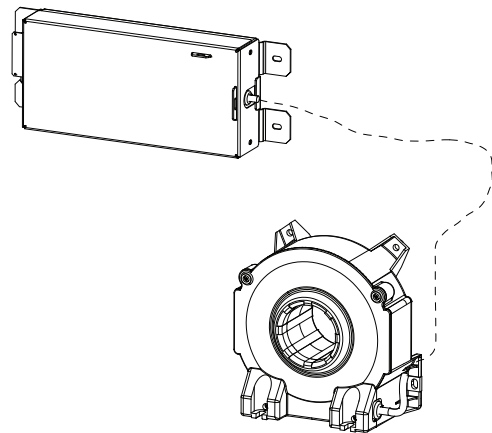

Features

- Bipolar and insulated current measurement up to 3 kA
- Current output
- Aperture for primary cable or bus bar and secondary connections on 15-pin D-Sub
- Other options possible for secondary connections.

Special features

- Screen
- Partially potted.

Advantages

- Exceptional accuracy (better than Class 0.5R)
- Low consumption and losses
- Good behavior under common mode variations
- High bandwidth
- Very low temperature drift
- High immunity to external interference.

Applications

- Energy metering
- Propulsion converter
- Substations
- Test and measurement.

Standards

- EN 50155: 2017
- EN 50124-1: 2017
- EN 50121-3-2: 2016
- EN 50463 series: 2017.

Application Domains

- Railway (fixed installations and onboard)
- Industrial.

Absolute maximum ratings

Parameter	Symbol	Value
Maximum supply voltage ($I_P = 0 \text{ A}$, 0.1 s)	$\pm \hat{U}_{C \text{ max}}$	$\pm 34 \text{ V}$
Maximum supply voltage (working) (-40 ... 85 °C)	$\pm U_{C \text{ max}}$	$\pm 26.4 \text{ V}$
Maximum primary current	$I_{P \text{ max}}$	100 kA
Maximum steady state primary current (-40 ... 85 °C)	$I_{P N \text{ max}}$	2000 A
Maximum steady state test winding current (-40 ... 85 °C)	$I_{T \text{ max}}$	1 A
Maximum /VALID output current		0.1 A
Maximum /VALID output voltage		Same limits as supply voltage

Absolute maximum ratings apply at 25 °C unless otherwise noted.

Stresses above these ratings may cause permanent damage. Exposure to absolute maximum ratings for extended periods may degrade reliability.

Insulation coordination

Parameter	Symbol	Unit	Value	Comment
RMS voltage for AC insulation test, 50 Hz, 1 min	U_d	kV	14	100 % tested in production
Impulse withstand voltage (1.2/50 μs exponential shape)	U_{Ni}	kV	30	
Partial discharge RMS test voltage ($q_m < 10 \text{ pC}$)	U_t	V	5000	Bar with centered
Insulation resistance	R_{INS}	M Ω	200	Measured at 500 V DC
Clearance (pri. - sec.)	d_{Cl}	mm	See dimensions drawing on page 13	Shortest distance through air
Creepage distance (pri. - sec.)	d_{Cp}	mm		Shortest path along device body
Case material	-	-	V0	According to UL 94
Comparative tracking index	CTI		600	

Environmental and mechanical characteristics

Parameter	Symbol	Unit	Min	Typ	Max	Comment
Ambient operating temperature	T_A	°C	-40		85	
Ambient storage temperature	$T_{A\text{st}}$	°C	-50		90	
Primary conductor temperature	T_B	°C			100	
Equipment operating temperature class						EN 50155: OT6
Switch-on extended operating temperature class						EN 50155: ST0
Rapid temperature variation class						EN 50155: H2
Conformal coating type						EN 50155: PC2
Relative humidity	RH	%			95	
Shock & vibration categorie and class						EN 50155: 1B, (EN 61373)
Mass	m	kg		5.2		
Ingress protection rating (head)				IP67		IEC 60529 (Indoor use)
Ingress protection rating (module)				IP20		
Pollution degree					PD4	Insulation voltage accordingly
Altitude		m			2000 ¹⁾	

Note: ¹⁾ Insulation coordination at 2000 m.

RAMS data

Parameter	Symbol	Unit	Min	Typ	Max	Comment
Useful life class						EN 50155: L4
Mean failure rate	λ	h ⁻¹		1/889384		According to IEC 62380 $T_A = 45$ °C ON: 20 hrs/day ON/OFF: 320 cycles/year $U_C = \pm 24$ V, $I_P = 2000$ A

Class accuracy

Parameter	Accuracy class	Comment
Class accuracy for a rated primary current $I_{PN} = 2000$ A	0.5R	according EN 50463-2
Class accuracy for a rated primary current $I_{PN} = 1500$ A	0.5R	according EN 50463-2
Class accuracy for a rated primary current $I_{PN} = 1000$ A	0.5R	according EN 50463-2
Class accuracy for a rated primary current $I_{PN} = 750$ A	0.5R	according EN 50463-2
Class accuracy for a rated primary current $I_{PN} = 500$ A	0.5R	according EN 50463-2

If used for energy measurement according to EN 50463, please note that the re-verification period of the transducer may be subject to national or international legal requirements.

Recommended re-verification period is at least 8 years.

Electrical data

At $T_A = 25\text{ °C}$, $\pm U_C = \pm 24\text{ V}$, $R_M = 0.1\ \Omega$, unless otherwise noted (see Min, Max, typ. definition paragraph in [page 5](#)).
 Lines with a * in the conditions column apply over the $-40 \dots 85\text{ °C}$ ambient temperature range.

Parameter	Symbol	Unit	Min	Typ	Max	Conditions
Primary nominal RMS current	I_{PN}	A			2000	*
Primary current, measuring range	I_{PM}	A	-3000		3000	*
Measuring resistance	R_M	Ω	0		2	* For $I_{PM} < 3\text{ kA}$, max value of R_M is given in figure 1
Secondary nominal RMS current	I_{SN}	A		0.8		*
Secondary current	I_S	A	-1.2		1.2	*
Supply voltage	$\pm U_C$	V	± 21.6	± 24	± 26.4	*
Rise time of U_C (10-90 %)	t_{rise}	ms			100	*
Current consumption	I_C	mA	45	54	70	$I_p = 0\text{ A}$, $\pm U_C = \pm 24\text{ V}$, valid for + and - supplies
Inrush current						NA (EN 50155)
Interruptions on power supply voltage class						NA (EN 50155)
Supply change-over class						NA (EN 50155)
Offset current, referred to primary	I_O	A	-0.01	0.004	0.01	23 °C; 100 % tested in production
Magnetic offset current, referred to primary	I_{OM}	A		0.005		After $I_p = 10\text{ kA}$
Temperature variation of I_O , referred to primary	I_{OT}	A	-0.05	-0.01	0.05	-40 ... 85 °C; 100 % tested in production
Sensitivity	S	mA/A		0.4		
Sensitivity error	ε_S	%	-0.005	-0.0002	0.005	
Temperature variation of sensitivity error	ε_{ST}	%	-0.01	0.002	0.01	* -40 ... 85 °C
Linearity error	ε_L	% of I_{PM}	-0.01	0.0004	0.01	* $\pm I_{PM}$ range
Total error at I_{PN}	ε_{tot}	% of I_{PN}	-0.01 -0.01	-0.0015 -0.0015	0.01 0.01	* 23 °C; 100 % tested in production; -40 ... 85 °C
Total error at 10 % of I_{PN}	ε_{tot}	% of reading	-0.1	-0.0040	0.1	23 °C; 100 % tested in production
Total error at 5 % of I_{PN}	ε_{tot}	% of reading	-0.2	-0.015	0.2	23 °C; 100 % tested in production
Total error at 1 % of I_{PN}	ε_{tot}	% of reading	-1	-0.03	1	23 °C; 100 % tested in production
Total error at 0.4 % of I_{PN}	ε_{tot}	A	-2.5	-0.3	2.5	23 °C
RMS noise current, referred to primary	I_{no}	A		2		1 Hz to 1 MHz
Delay time @ 90 % of the final output value I_{PN} step	t_{D90}	μs		0.1		0 to 2 kA, 100 A/ μs
Frequency bandwidth	BW	kHz		27 23 3		3 dB, 100 A 1 dB, 100 A 0.1 dB, 100 A
Start-up time	t_{start}	ms		400	500	*
Number of secondary turns	N_S			2500		
Number of turns (test winding)	N_T			200		

Definition of typical, minimum and maximum values

Minimum and maximum values for specified limiting and safety conditions have to be understood as such as well as values shown in “typical” graphs.

On the other hand, measured values are part of a statistical distribution that can be specified by an interval with upper and lower limits and a probability for measured values to lie within this interval.

Unless otherwise stated (e.g. “100 % tested”), the LEM definition for such intervals designated with “min” and “max” is that the probability for values of samples to lie in this interval is 99.73 %.

For a normal (Gaussian) distribution, this corresponds to an interval between -3 sigma and +3 sigma. If “typical” values are not obviously mean or average values, those values are defined to delimit intervals with a probability of 68.27 %, corresponding to an interval between -sigma and +sigma for a normal distribution.

Typical, maximal and minimal values are determined during the initial characterization of the product.

Typical performance characteristics

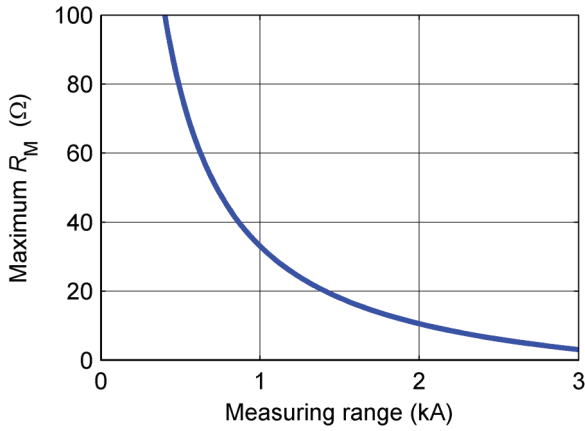

Figure 1: Maximum measuring resistance ($T_A = -40 \dots 85 \text{ }^\circ\text{C}$)

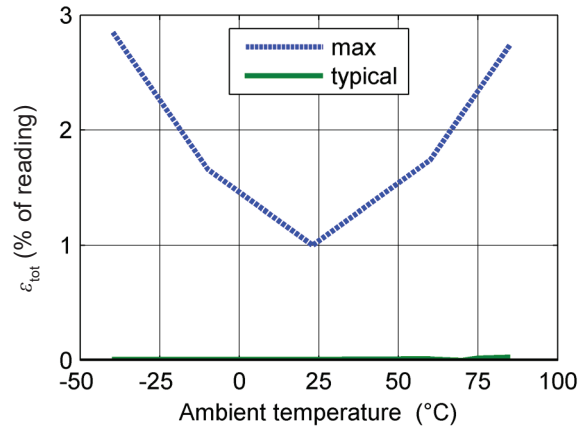

Figure 2: Total error in temperature for $0.1 I_{PN} \leq I_P \leq 1.2 I_{PN}$

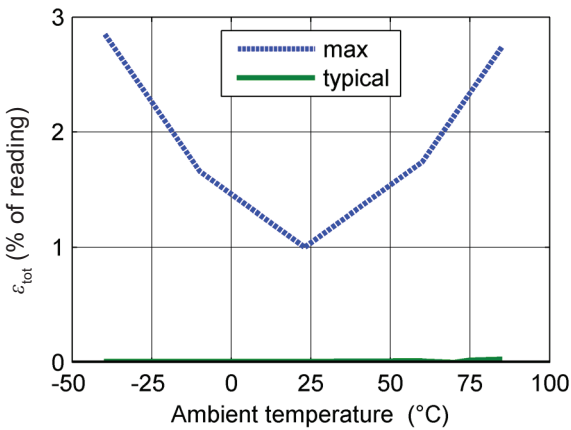

Figure 3: Total error in temperature for $0.05 I_{PN} \leq I_P < 0.1 I_{PN}$

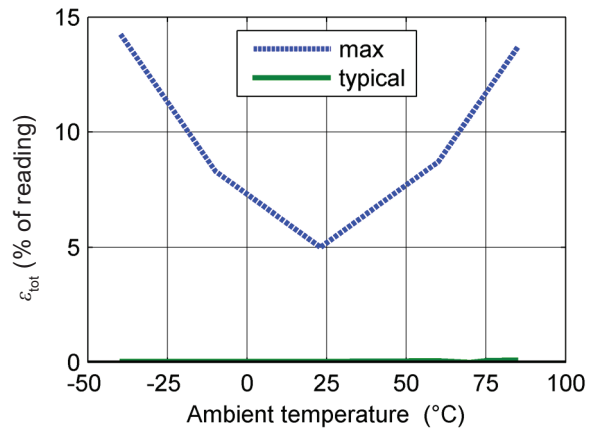

Figure 4: Total error in temperature for $0.01 I_{PN} \leq I_P < 0.05 I_{PN}$

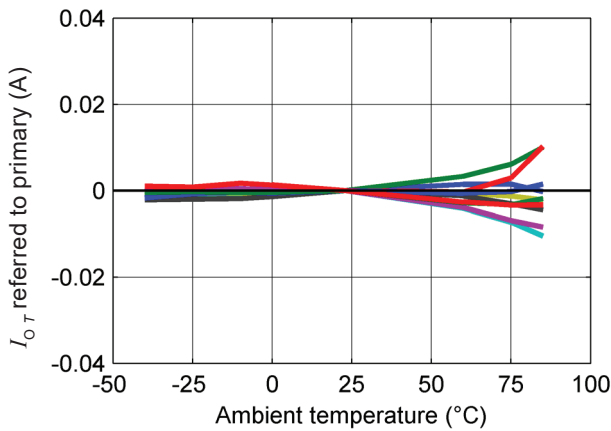

Figure 5: Typical offset variation in temperature (10 samples shown)

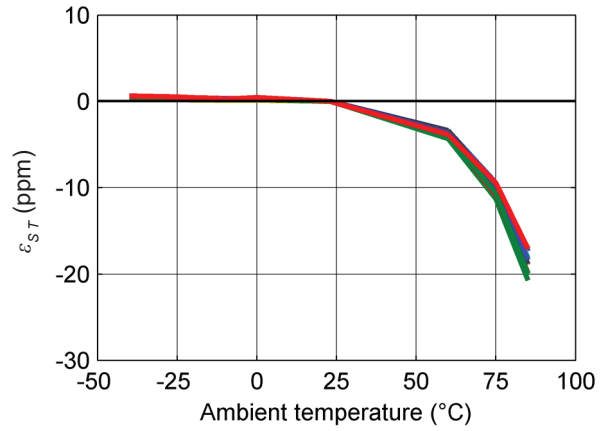

Figure 6: Typical sensitivity variation in temperature (10 samples shown)

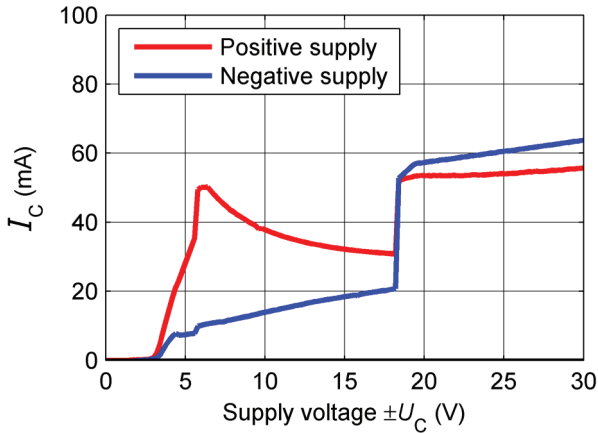

Figure 7: Typical supply current function of supply voltage ($I_p = 0 A$)

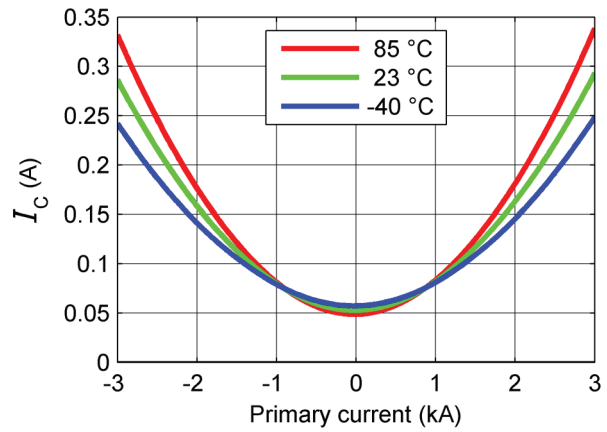
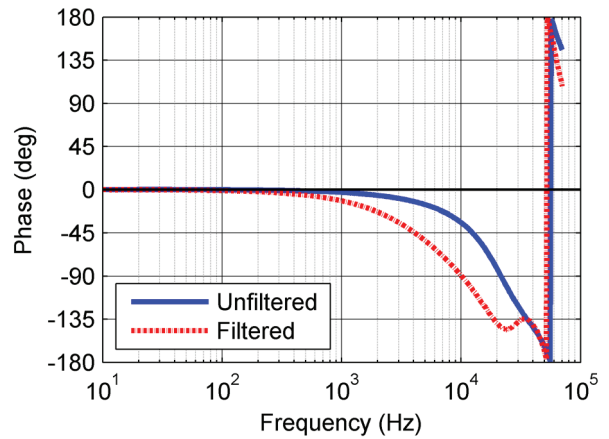
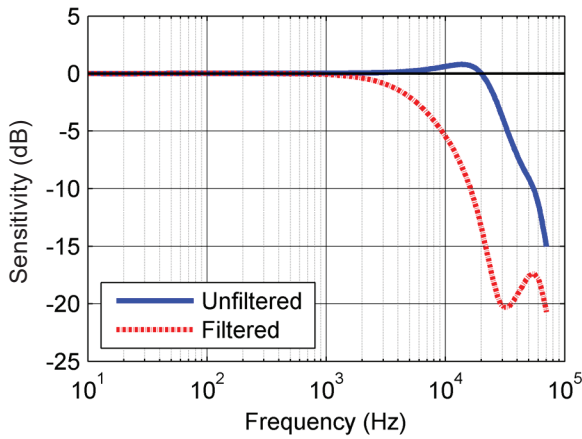
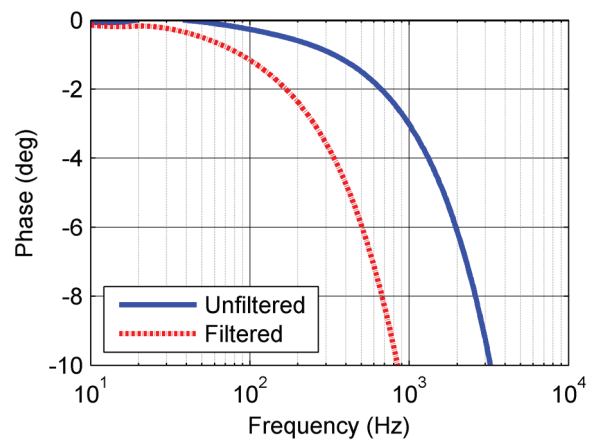
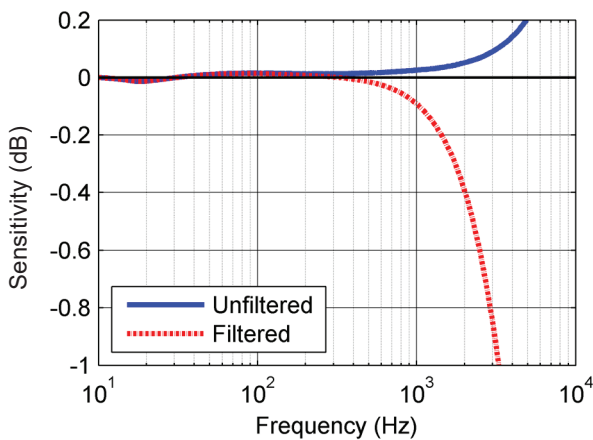

Figure 8: Typical supply current function of primary current ($R_M = 0.1 \Omega$, $\pm U_C = \pm 24 V$) (both supply currents are identical)



Figures 9, 10: Typical frequency response, $I_p = 100 A$ RMS
Filtered output was measured with a 10 kHz 1st order low pass filter



Figures 11, 12: Typical frequency response (detail), $I_p = 100 A$ RMS
Filtered output was measured with a 10 kHz 1st order low pass filter

Typical performance characteristics

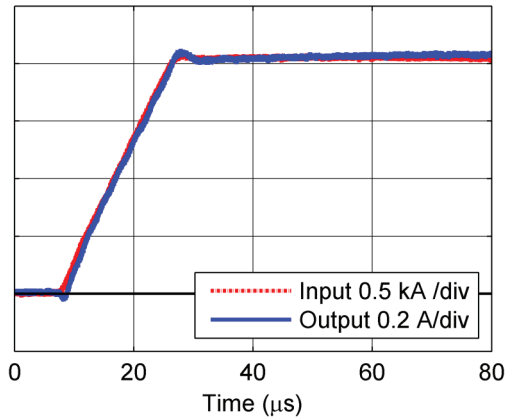

Figure 13: Typical step response (0 to 2 kA, 100 A/μs)

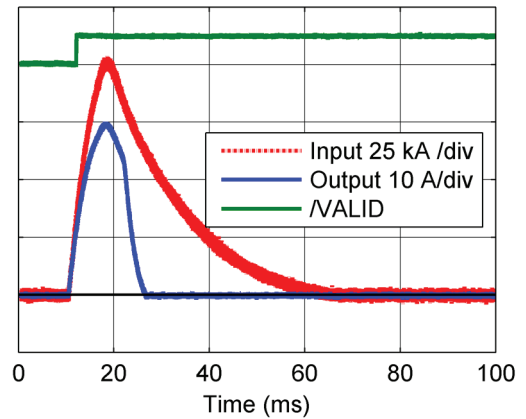

Figure 14: 100 kA overload behaviour

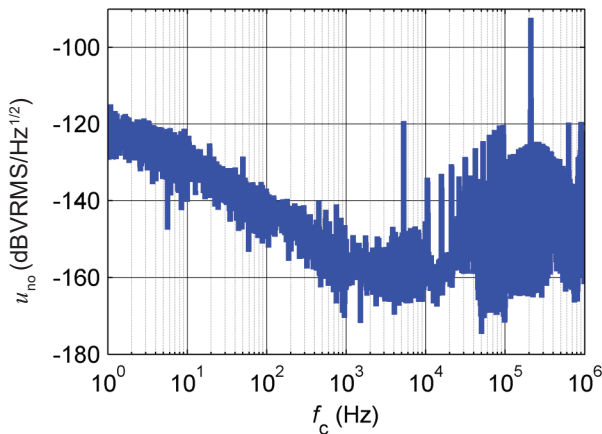

Figure 15: Typical noise voltage density u_{no} with $R_M = 1 \Omega$

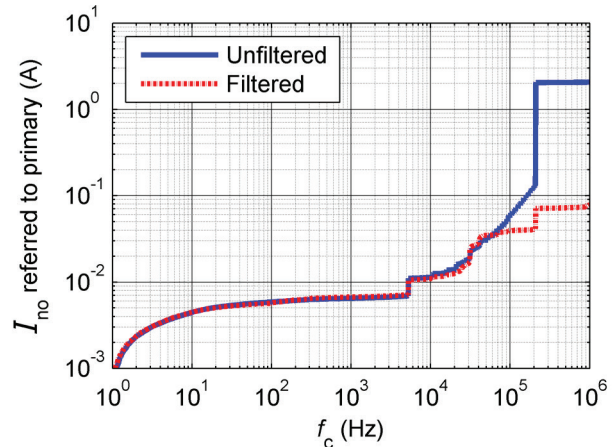

Figure 16: Typical total current noise (primary referred, RMS) with $R_M = 1 \Omega$ (f_c is upper cut off frequency of bandpass, low cut off frequency is 1 Hz). Filtered output was measured with 10 kHz 1st order low pass filter.

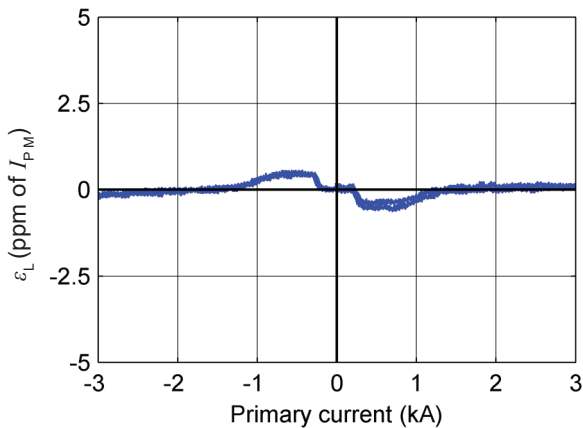

Figure 17: Typical linearity error

Figure 15 (noise voltage density) shows that there are two discrete frequencies in the output. Figure 16 confirms that because there are steps in the total output current noise at around 6 and 200 kHz. The 10 kHz filter reduces by a large amount the high frequency noise. To calculate the noise in a frequency band f_1 to f_2 , the formula is:

$$I_{no}(f_1 \text{ to } f_2) = \sqrt{I_{no}(f_2)^2 - I_{no}(f_1)^2}$$

with $I_{no}(f)$ read from figure 16 (typical, RMS value).

Example:

What is the noise from 10 to 1000 Hz?

Figure 16 gives $I_{no}(10 \text{ Hz}) = 4 \text{ mA}$ and $I_{no}(1000 \text{ Hz}) = 6.5 \text{ mA}$. The output current noise (RMS) is therefore.

$$\sqrt{(6.5 \cdot 10^{-3})^2 - (4 \cdot 10^{-3})^2} = 5.1 \text{ mA referred to primary}$$

Typical performance characteristics

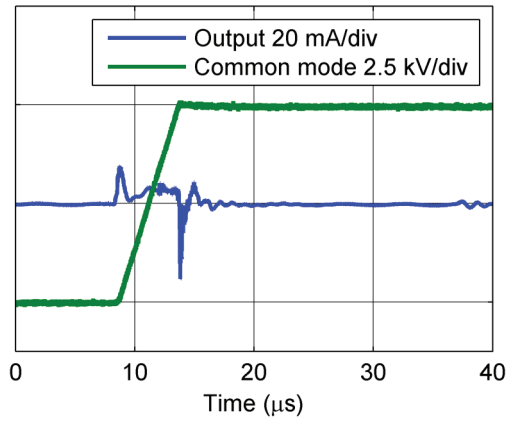

Figure 18: Typical common mode perturbation, unfiltered output (5 kV step with 1 kV/μs, $R_M = 1 \Omega$)

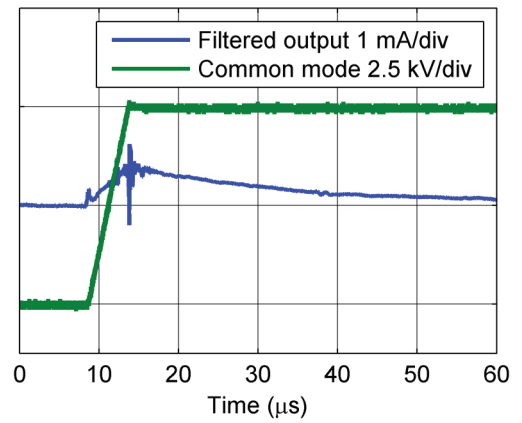

Figure 19: Typical common mode perturbation with 10 kHz 1st order low pass filter on the output (5 kV step with 1 kV/μs, $R_M = 1 \Omega$)

General description

The ITC 2000 transducer is a closed loop current transducer based on the fluxgate principle for the isolated yet accurate measurement of currents up to 3 kA.

Its Class D power stage greatly reduces the power consumption compared to standard designs and allows function without limitation with an ambient temperature from -40 ... 85 °C.

Closed loop transducer

The ITC is a compensated current transducer (also called closed loop): it means that the current in the secondary coil is regulated so that the magnetic flux it creates in the main toroidal core compensates exactly the flux generated by the primary current.

This implies that the magnetic potential (ampere-turns) of the two coils are identical, hence:

$$N_p \cdot I_p = N_s \cdot I_s \text{ or } I_s = I_p \cdot N_p / N_s \text{ also written } I_s = S \cdot I_p \text{ with } -N_p \text{ and } N_s \text{ the turns numbers of the primary and compensation (or secondary) windings, } -S = N_p / N_s \text{ the sensitivity of the transducer}$$

Consequently, the secondary current I_s is the exact image of the primary current I_p being measured.

Inserting a measuring resistor R_M in series with the compensation coil (see figure 20) creates an output voltage that is an exact image of the measured current from DC to high frequencies.

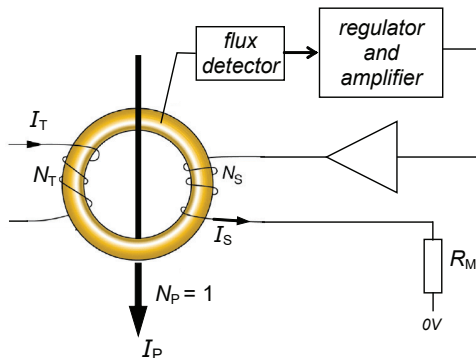

Figure 20: Principle of ITC transducer

Fluxgate

A fluxgate detector measures the resulting magnetic flux. It uses an inductor, the fluxgate, composed of a thin toroid with a coil around it and placed in the center of the main core halves (see figure 21).

The electronics saturate the fluxgate in both directions and analyzes the symmetry of the fluxgate's saturation currents to extract the actual flux value.

The fluxgate detector developed for the ITC is very stable in temperature, which gives the ITC its outstanding accuracy stability.

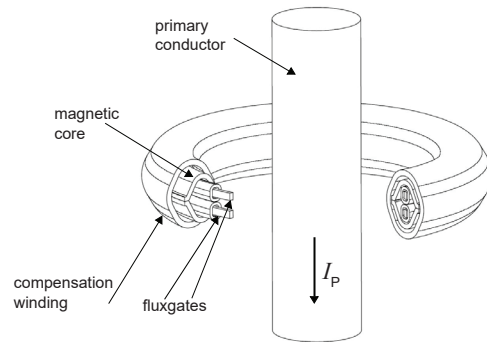

Figure 21: ITC head construction

Output stage

The output stage of the ITC uses a Class D amplifier to limit both the power consumption of the transducer and its losses. In this type of switched-mode amplifier both transistors of the output bridge are turned on and off alternatively by a PWM signal as shown in figure 22 and 23. The losses are therefore only caused by the $R_{ds(on)}$ and the turn-on and -off losses of the transistors T1H and T1L. Compared to the industry standard, which is the Class AB (linear), the Class D allows the losses in the transistors to be reduced by a factor close to 10, removing the need for large heatsinks and improving the reliability of the electronics. A built-in second order filter attenuates the harmonics to a very low level.

The ITC moreover uses a proprietary technique to balance the supply currents which results in reduced and almost equal supply currents drawn from both supplies whatever the input current measured (I_H and I_L in figure 22). See also figure 8.

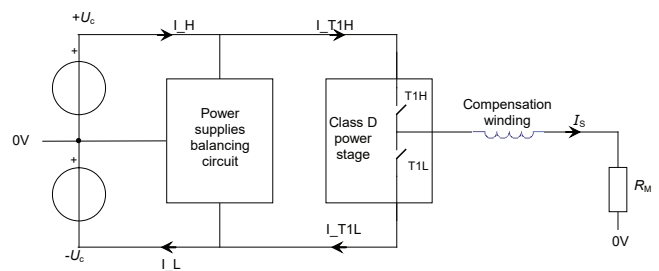

Figure 22: Power stage principle

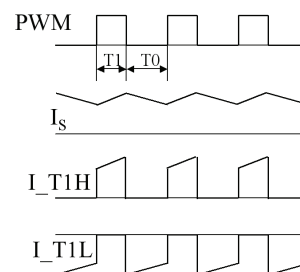

Figure 23: Current in transistors

Overload behavior and /INVALID output

The electronics cannot maintain the flux compensation if the primary current becomes higher than the measuring range. If this state lasts too long the fluxgate detector becomes completely saturated and unable to measure the flux error. When this happens, the transducer stops for 300 to 500 ms and then sweeps the output current to find the point at which compensation is correct again and the normal function can resume. This behavior is shown in figure 24.

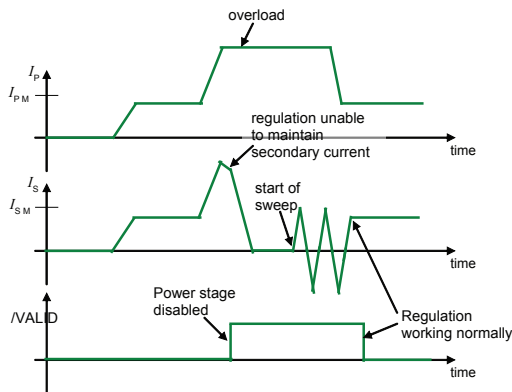

Figure 24: Overload behaviour

The logic output /INVALID is an open collector. The pull-up resistor R_{pu} is external to the transducer (see figure 25). It is activated (pulled to 0 V) to indicate that the regulation of the output current works normally. It is deactivated (pulled to the high level) to indicate that the output current is not the exact image of the primary current. It happens during the start-up of the transducer, after a large overcurrent, if there is an internal fault or if the measuring resistance is disconnected while a primary current is present.

The transducer is protected against overloads up to 100 kA without duration limit. In such a case, it will stop to protect itself and /INVALID will be deactivated. Even if the compensation winding current is very high thanks to the transformer effect, there is no high current drawn from the supplies or reinjected in the supplies. For very low measuring resistances values, there might be a current close to $I_p \cdot S$ in the measuring resistance until the core saturates (typically 15 ms for 100 kA).

Test winding

A test winding is wound around the compensation winding. It allows simulating a primary current to test the function and accuracy of the transducer at 10 % of its nominal.

The output current I_s for a test current I_T is $I_s = N_t/N_s \cdot I_T$.

The current injected in the test winding must be generated by a current source (high impedance).

When the test winding is not used, it must stay opened.

Performance parameters definition

The schematic used to measure all electrical parameters are:

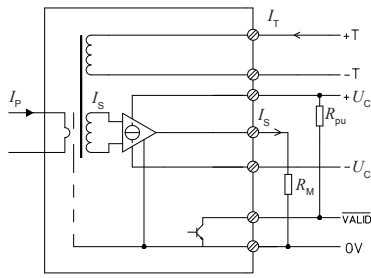

Figure 25: Standard characterization schematics for current output transducers

Transducer simplified model

The static model of the transducer at temperature T_A is:

$$I_S = S \cdot I_P + \varepsilon$$

In which

$$\varepsilon = I_{OE} + I_{OT}(T_A) + \varepsilon_S \cdot S \cdot I_P + \varepsilon_{ST}(T_A) \cdot S \cdot I_P + \varepsilon_L \cdot S \cdot I_{PM} + I_{OM}$$

- I_S : secondary current (A)
- S : sensitivity of the transducer (A/A)
- I_P : primary current (A)
- I_{PM} : primary current, measuring range (A)
- T_A : ambient operating temperature (°C)
- I_{OE} : electrical offset current (A)
- I_{OM} : magnetic offset current (A)
- $I_{OT}(T_A)$: temperature variation of I_{OE} at temperature T_A (A)
- ε_S : sensitivity error at 25 °C
- $\varepsilon_{ST}(T_A)$: thermal drift of sensitivity at temperature T_A
- ε_L : linearity error

This is the absolute maximum error. As all errors are independent, a more realistic way to calculate the error would be to use the following formula:

$$\text{error} = \sqrt{\sum(\text{error_component})^2}$$

Sensitivity and linearity

To measure sensitivity and linearity, the primary current (DC) is cycled from 0 to I_{PM} , then to $-I_{PM}$ and back to 0 (equally spaced $I_{PM}/10$ steps).

The sensitivity S is defined as the slope of the linear regression line for a cycle between $\pm I_{PM}$.

The linearity error ε_L is the maximum positive or negative difference between the measured points and the linear regression line, expressed in % of the maximum measured value.

Magnetic offset

The magnetic offset I_{OM} is the change of offset after a given current has been applied to the input. It is included in the linearity error as long as the transducer remains in its measuring range. Due to its working principle, this type of transducer has small magnetic offset current.

Electrical offset

The electrical offset current I_{OE} is the residual output current when the input current is zero (magnetic offset removed).

The temperature variation I_{OT} of the electrical offset current I_{OE} is the variation of the electrical offset from 25 °C to the considered temperature.

Total error

The total error ε_{tot} is the error at a given current (I_{PN} if not mentioned), relative to the rated value I_{PN} or to the reading. It includes all errors mentioned above.

Delay times

The delay time t_{D10} and the delay time t_{D90} are shown in the next figure.

Both slightly depend on the primary current di/dt .

They are measured at nominal current.

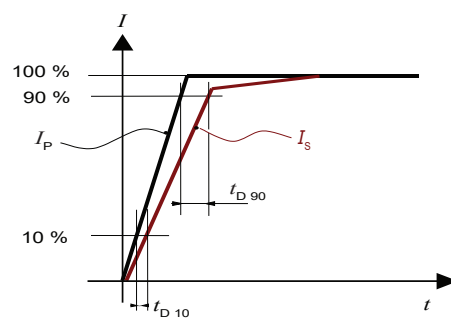
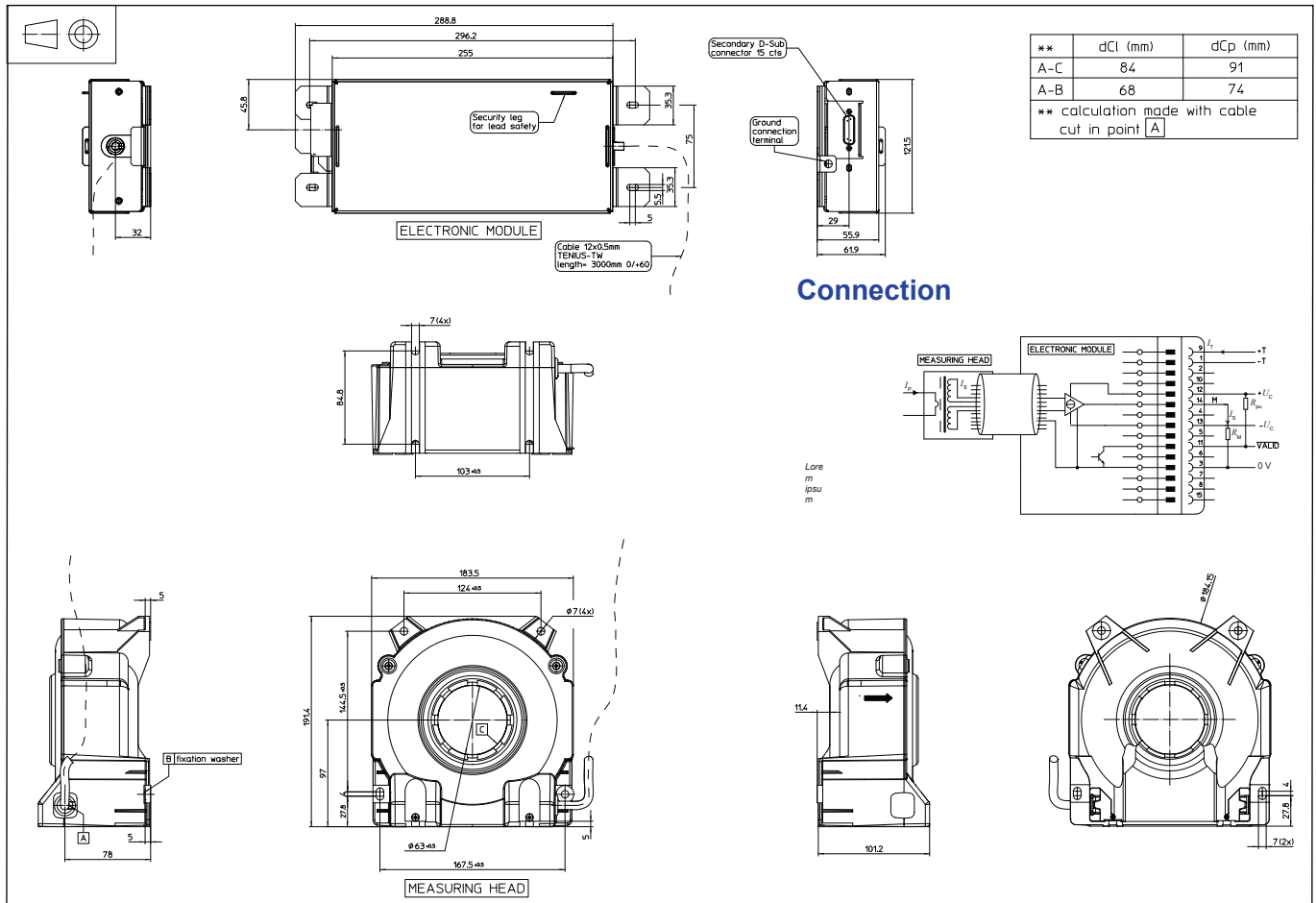
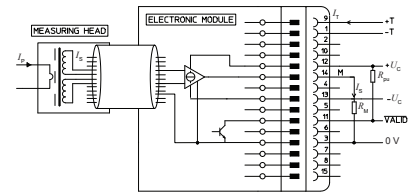

Figure 26: t_{D10} (delay time to 10 %) and t_{D90} (delay time to 90 %)

Dimensions (in mm)



Connection



Mechanical characteristics

- General tolerance: ±1 mm
- Measuring head: 4 slots or holes ø 7 mm
- Transducer fastening: 4 M6 steel screws
- Recommended fastening torque: 5 N·m (±10 %)
- Electronic module: D-Sub male connector
- Output connection: 15 cts with M3 hexagonal locking screws
- Electronic module fastening: 4 M5 screw
- Recommended fastening torque: 5 N·m (±10 %)

Note: Additional information available on request.

Safety



This transducer must be used in electric/electronic equipment with respect to applicable standards and safety requirements in accordance with the manufacturer's operating instructions.



Caution, risk of electrical shock

Remarks

- I_s is positive when I_p flows in the direction of arrow.
- The secondary cables also have to be routed together all the way.
- Installation of the transducer is to be done without primary or secondary voltage present.
- Maximum temperature of primary conductor: see page 2
- Installation of the transducer must be done unless otherwise specified on the datasheet, according to LEM Transducer Generic Mounting Rules. Please refer to LEM document N°ANE120504 available on our Web site: <https://www.lem.com/en/file/3137/download>.

When operating the transducer, certain parts of the module can carry hazardous voltage (eg. primary busbar, power supply). Ignoring this warning can lead to injury and/or cause serious damage. This transducer is a build-in device, whose conducting parts must be inaccessible after installation. A protective housing or additional shield could be used. Main supply must be able to be disconnected.